

# FEPRO

[solutions that work]





# FEPRO

[solutions that work]

## Mission

At Fepro, our mission is to blend outstanding design and functionality with cost-efficient manufacturing. Since 2005, we've been pioneering the development of smoking ban products and pet waste maintenance systems for urban outdoor use, supplying industry leaders around the globe with functional, high-quality products.

## Portfolio

Today, our portfolio features a comprehensive range of signage products as well as our large range of waste receptacles and dispensers for professional use. Our products are made of durable materials such as stainless steel, galvanized steel, and polycarbonate. You can order them as shown or have them customized in line with your branding and packaging requirements.

## Your benefits

### Functional products with appealing design

All our products meet the highest quality standards. We develop, manufacture and deliver our products based on specific market needs. This is how we can guarantee perfect functionality and superior design.

### Product range and flexibility

As a reseller or direct seller, you will benefit from our large portfolio, flexible order quantities and various product combinations. This will allow you to provide the exact products your customers need while keeping your inventory low and your warehousing costs at a minimum.

### Efficient ordering

Fepro makes ordering easy and efficient. Our professional customer service team will support you personally throughout the ordering process, update you proactively about your order status and prepare all the documents for a smooth delivery.



## Index

### Displays

- Floor Standing Frames & Sign Holders
- Digital Signage Stands
- Floor Standing Brochure & Literature Holders
- Wall Brochure & Literature Holders
- Suggestion, Ballot & Donation Boxes
- Tabletop & Counter Brochure Holders
- Tabletop & Counter Sign Holders
- Wall Frames & Sign Holders
- Hanging Frames & Sign Holders

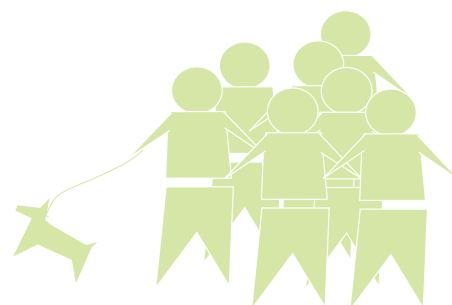

### Facility Supply

- Waste Receptacles
- Cigarette Receptacles
- Canine Dispensers / Dog Poop Bags
- Crowd Control
- Dispensers

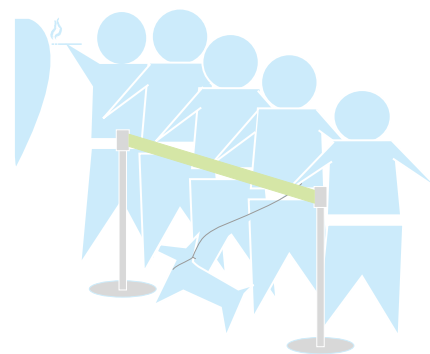

fepro  
displays

p 06 - 26

p 22 - 25

p 27 - 31

p 32 - 37

p 38 - 41

p 42 - 45

p 46 - 63

p 64 - 77

p 78 - 85

- Floor Standing Frames & Sign Holders
- Digital Signage Stands
- Floor Standing Brochure & Literature Holders
- Wall Brochure & Literature Holders
- Suggestion, Ballot & Donation Boxes
- Tabletop & Counter Brochure Holders
- Tabletop & Counter Sign Holders
- Wall Frames & Sign Holders
- Hanging Frames & Sign Holders



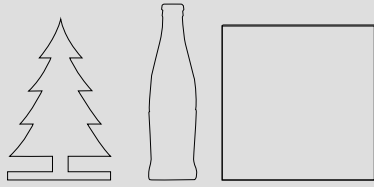

Printed boards for Uni Clip 50° and Uni Clip Flex

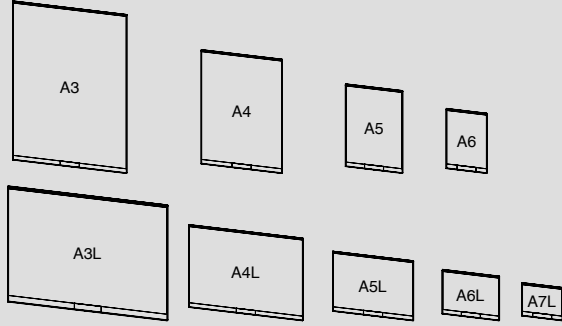

Uni Clip Sign for Uni Clip Alu, Uni Clip 50° and Uni Clip Flex

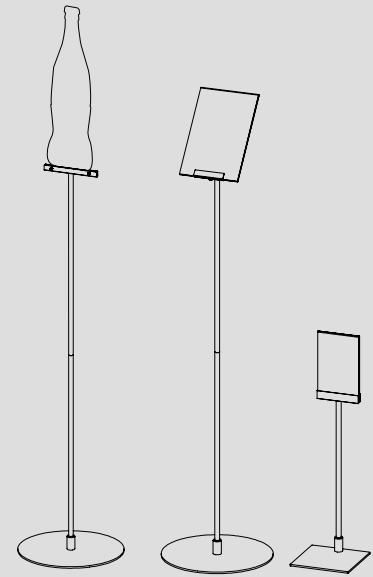

# Instand

Adapt to various customer needs with a system that allows multiple configurations, at a competitive price.

Uni Frame

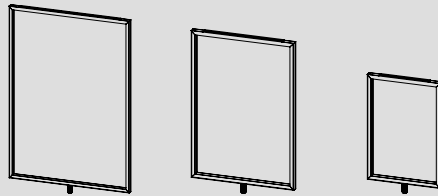

Info Frame



Uni Clip 50°



Uni Clip Flex

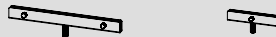

Uni Clip Alu

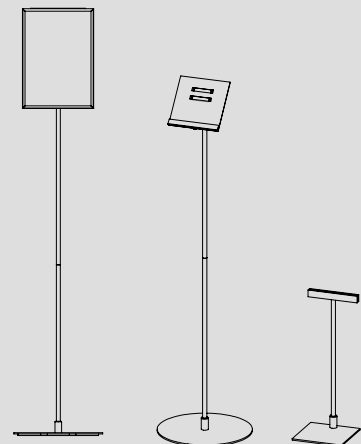

Instand Pole

- 3 Fixed Sizes
- 2 Telescope Sizes
- Floor Standing or Table/Counter
- 2 Colors White and Black

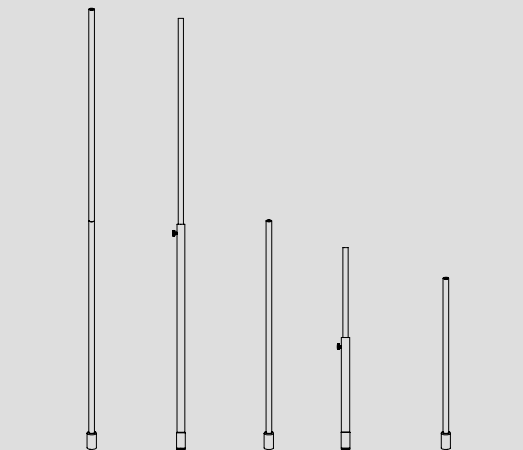

Instand Base

- 2 Sizes
- 3 Different mounts
- 2 Colors White and Black

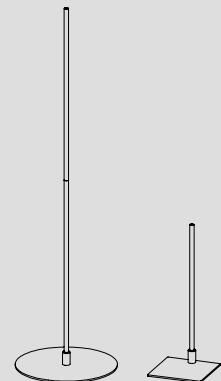

Instand Maxi Straight Page 9

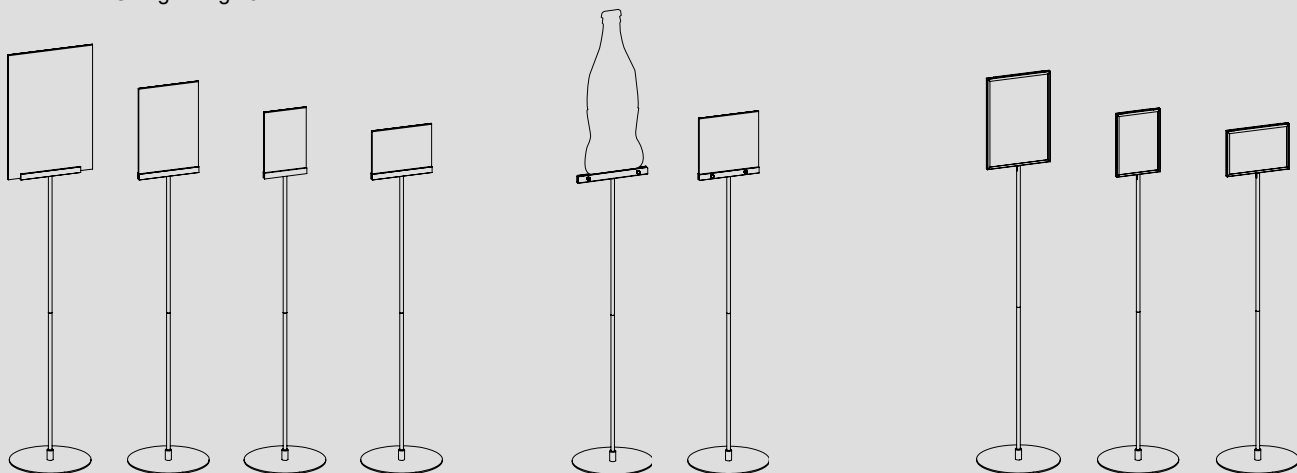

Instand Midi Straight Page 11

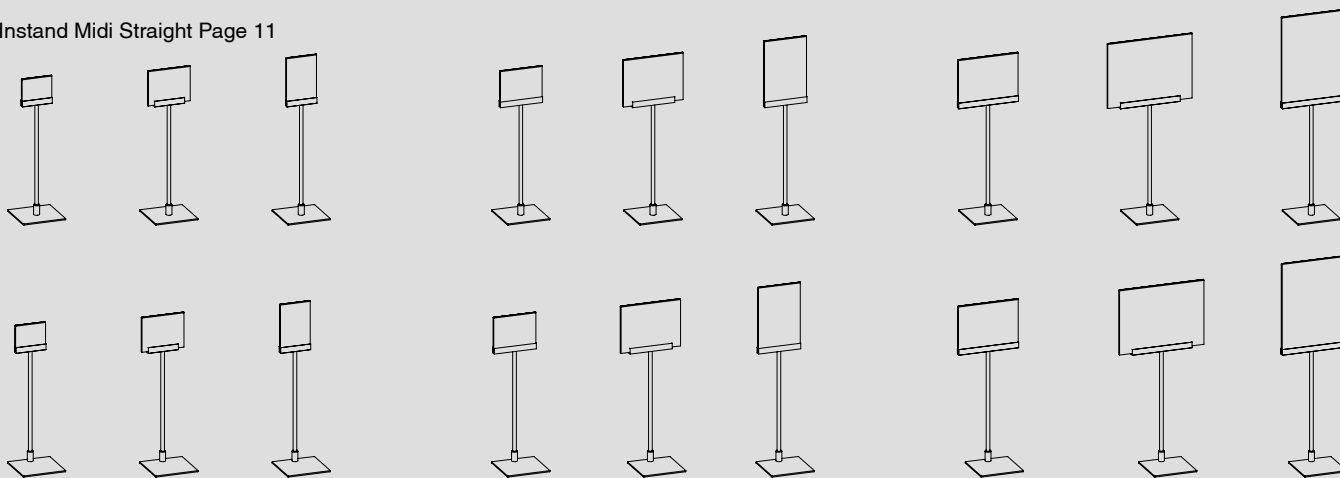

Instand Maxi Angled Page 13

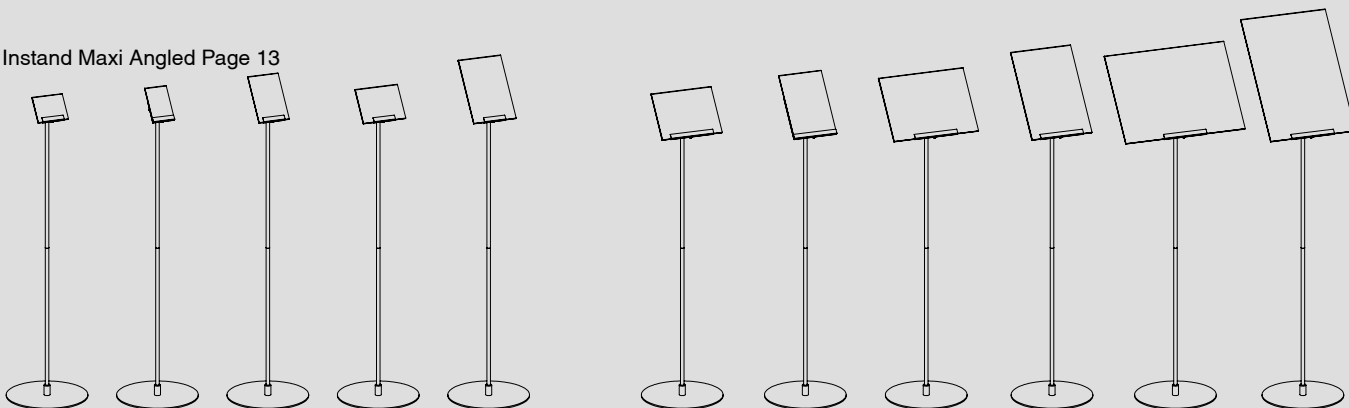

Instand Midi Angled Page 12

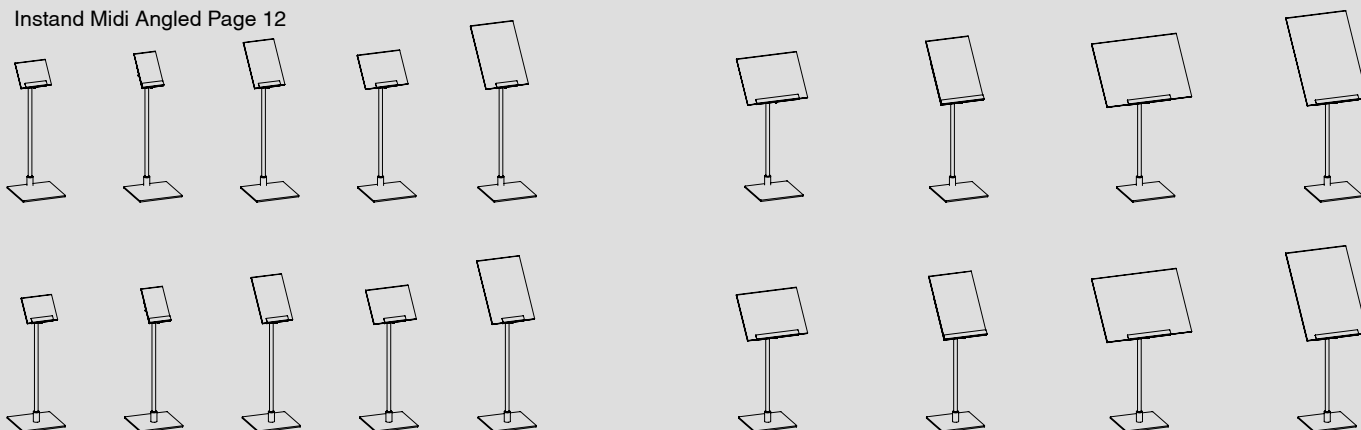







## Instand Maxi Straight

The classy way to display a message, either in our UNI CLIP SIGNS folded acrylic pockets, available in sizes from A7 landscape to A3, or with printed boards with a thickness ranging from 2mm to 6mm.

- Modular design
- Slim, elegant look
- Matte coating Black or White
- Compatible with all Uni Clips and Uni Clip Signs
- Packaging optimized for online retail: In bulk packing for customizable sets or pre-packaged sets ready dispatch



Uni Clip Flex



Uni Clip Alu



Uni Frame

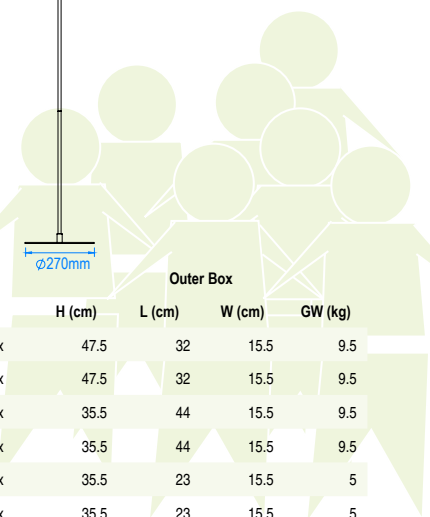
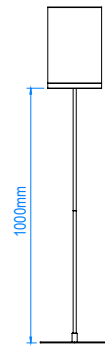

Item #	Item Description	PU	Outer Box			
			H (cm)	L (cm)	W (cm)	GW (kg)
02837	Uni Frame, A3, Black. Incl. Pocket	10 in 1 Bulk Box	47.5	32	15.5	9.5
03059	Uni Frame, A3, White. Incl. Pocket	10 in 1 Bulk Box	47.5	32	15.5	9.5
02838	Uni Frame, A3L, Black. Incl. Pocket	10 in 1 Bulk Box	35.5	44	15.5	9.5
03058	Uni Frame, A3L, White. Incl. Pocket	10 in 1 Bulk Box	35.5	44	15.5	9.5
02836	Uni Frame, A4, Black. Incl. Pocket	10 in 1 Bulk Box	35.5	23	15.5	5
03060	Uni Frame, A4, White. Incl. Pocket	10 in 1 Bulk Box	35.5	23	15.5	5
02840	Uni Frame, A4L, Black. Incl. Pocket	10 in 1 Bulk Box	26.5	32	15.5	5
03061	Uni Frame, A4L, White. Incl. Pocket	10 in 1 Bulk Box	26.5	32	15.5	5
02835	Uni Frame, A5, Black. Incl. Pocket	10 in 1 Bulk Box	26.5	17	15.5	3
03062	Uni Frame, A5, White. Incl. Pocket	10 in 1 Bulk Box	26.5	17	15.5	3
02839	Uni Frame, A5L, Black. Incl. Pocket	10 in 1 Bulk Box	20.5	23	15.5	3
03063	Uni Frame, A5L, White. Incl. Pocket	10 in 1 Bulk Box	20.5	23	15.5	3
02727	Uni Clip Flex 10.5, Black	50 in 1 Box	16	33	28	4.8
03044	Uni Clip Flex 10.5, White	50 in 1 Box	16	33	28	4.8
00913	Uni Clip Flex 21, Black	50 in 1 Box	27	32	27	8
03045	Uni Clip Flex 21, White	50 in 1 Box	27	32	27	8
02510	Uni Clip, Alu, 10.5, Black	100 in 1 Box	25	29	22	8.5
03046	Uni Clip, Alu, 10.5, White	100 in 1 Box	25	29	22	8.5
02514	Uni Clip, Alu, 21, Black	100 in 1 Box	25	43	25	16.5
03047	Uni Clip, Alu, 21, White	100 in 1 Box	25	43	25	16.5
02502	Instand Pole, 35, Black	100 in 1 Box	26	46	15	12.5
03039	Instand Pole, 35, White	100 in 1 Box	26	46	15	12.5
02503	Instand Pole, 48, Black	200 in 1 Box	29	55.5	25	25.5
03040	Instand Pole, 48, White	200 in 1 Box	29	55.5	25	25.5
02495	Instand Pole, 96 (2x48), Black	100 in 1 Box	27	55	29	26.5
03041	Instand Pole, 96 (2x48), White	100 in 1 Box	27	55	29	26.5
02494	Instand Base, 27Dia, Black	10 in 1 Bulk Box	13	28.5	28	19
03037	Instand Base, 27Dia, White	10 in 1 Bulk Box	13	28.5	28	19





Instand Base, 15Sq, CTR,

Instand Base, 15Sq, TOP



Uni Clip Flex



Uni Clip Alu



Uni Frame

## Instand Midi, Straight

The Instand Midi is available with two square bases: one with a center hole and one with a top-centered hole. Perfect for countertops, tables, or shop racks. Compatible with our UNI CLIP SIGNS foldover acrylic pockets (A7 landscape to A3) or printed boards with a thickness of 2mm to 6mm.

- Straight Sign
- Modular design
- Slim, classy look
- Matte surface

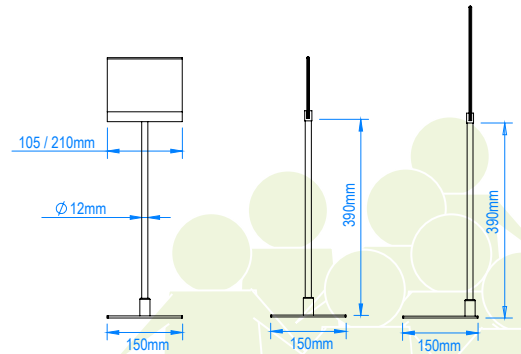

Item #	Item Description	PU	Outer Box			
			H (cm)	L (cm)	W (cm)	GW (kg)
02837	Uni Frame, A3, Black. Incl. Pocket	10 in 1 Bulk Box	47.5	32	15.5	9.5
03059	Uni Frame, A3, White. Incl. Pocket	10 in 1 Bulk Box	47.5	32	15.5	9.5
02838	Uni Frame, A3L, Black. Incl. Pocket	10 in 1 Bulk Box	35.5	44	15.5	9.5
03058	Uni Frame, A3L, White. Incl. Pocket	10 in 1 Bulk Box	35.5	44	15.5	9.5
02836	Uni Frame, A4, Black. Incl. Pocket	10 in 1 Bulk Box	35.5	23	15.5	5
03060	Uni Frame, A4, White. Incl. Pocket	10 in 1 Bulk Box	35.5	23	15.5	5
02840	Uni Frame, A4L, Black. Incl. Pocket	10 in 1 Bulk Box	26.5	32	15.5	5
03061	Uni Frame, A4L, White. Incl. Pocket	10 in 1 Bulk Box	26.5	32	15.5	5
02835	Uni Frame, A5, Black. Incl. Pocket	10 in 1 Bulk Box	26.5	17	15.5	3
03062	Uni Frame, A5, White. Incl. Pocket	10 in 1 Bulk Box	26.5	17	15.5	3
02839	Uni Frame, A5L, Black. Incl. Pocket	10 in 1 Bulk Box	20.5	23	15.5	3
03063	Uni Frame, A5L, White. Incl. Pocket	10 in 1 Bulk Box	20.5	23	15.5	3
02727	Uni Clip Flex 10.5, Black	50 in 1 Box	16	33	28	4.8
03044	Uni Clip Flex 10.5, White	50 in 1 Box	16	33	28	4.8
00913	Uni Clip Flex 21, Black	50 in 1 Box	27	32	27	8
03045	Uni Clip Flex 21, White	50 in 1 Box	27	32	27	8
02510	Uni Clip, Alu, 10.5, Black	100 in 1 Box	25	29	22	8.5
03046	Uni Clip, Alu, 10.5, White	100 in 1 Box	25	29	22	8.5
02514	Uni Clip, Alu, 21, Black	100 in 1 Box	25	43	25	16.5
03047	Uni Clip, Alu, 21, White	100 in 1 Box	25	43	25	16.5
02502	Instand Pole, 35, Black	100 in 1 Box	26	46	15	12.5
03039	Instand Pole, 35, White	100 in 1 Box	26	46	15	12.5
02503	Instand Pole, 48, Black	200 in 1 Box	29	55.5	25	25.5
03040	Instand Pole, 48, White	200 in 1 Box	29	55.5	25	25.5
02500	Instand Base, 15Sq, CTR, Black	20 in 1 Bulk Box	31	16	16	15
03035	Instand Base, 15Sq, CTR, White	20 in 1 Bulk Box	31	16	16	15
02501	Instand Base, 15Sq, TOP, Black	20 in 1 Bulk Box	31	16	16	15
03036	Instand Base, 15Sq, TOP, White	20 in 1 Bulk Box	31	16	16	15



## Instand Midi, Angled

The Instand Angled system uses a 50° Uni Clip Adapter and Info Frame to display signs at a 50° angle, enhancing visibility in various settings

- 50° Display Angle: easy sign readability and visibility.
- Simple Adapter: Uni Clip Adapter allows easy sign placement.
- Practical Design: Maintains a clean and functional appearance.
- Matte Finish Options: Available in Black or White.
- Compatible: Works with Info Frame and all Uni Clips and Uni Clip Signs.
- Optimized Packaging: Available in bulk or pre-packaged sets.

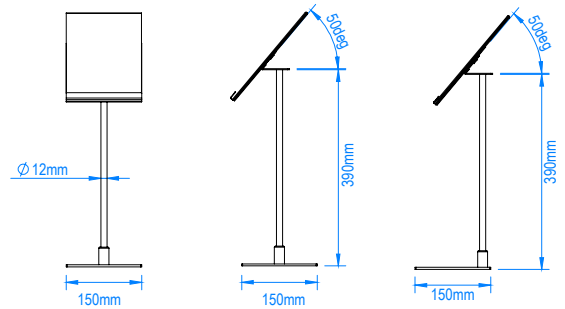

Instand Base, 15Sq, CTR

Instand Base, 15Sq, TOP

Item #	Item Description	PU	Outer Box			
			H (cm)	L (cm)	W (cm)	GW (kg)
03066	Info Frame, Black A4, with Mag Foil Black	10 in 1 Bulk Box	39	26	20	10
03086	Info Frame, White A4, with Mag Foil White	10 in 1 Bulk Box	39	26	20	10
02497	Uni Clip 15, 50°, Black	20 in 1 Box	20	39	39	7.5
03042	Uni Clip 15, 50°, White	20 in 1 Box	20	39	39	7.5
02643	Uni Clip 7.5, 50°, Black	40 in 1 Box	21	38	40	8.4
03043	Uni Clip 7.5, 50°, White	40 in 1 Box	21	38	40	8.4
02502	Instand Pole, 35, Black	100 in 1 Box	26	46	15	12.5
03039	Instand Pole, 35, White	100 in 1 Box	26	46	15	12.5
02503	Instand Pole, 48, Black	200 in 1 Box	29	55.5	25	25.5
03040	Instand Pole, 48, White	200 in 1 Box	29	55.5	25	25.5
02500	Instand Base, 15Sq, CTR, Black	20 in 1 Bulk Box	31	16	16	15
03035	Instand Base, 15Sq, CTR, White	20 in 1 Bulk Box	31	16	16	15
02501	Instand Base, 15Sq, TOP, Black	20 in 1 Bulk Box	31	16	16	15
03036	Instand Base, 15Sq, TOP, White	20 in 1 Bulk Box	31	16	16	15

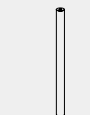

## Instand Maxi, Angled

The Instand Maxi coupled with our 50° Uni Clip Adapter or Info Frame with a round base, providing a sleek looking Info sign stand.

- 50° Display Angle: better sign readability
- Round Base: Ensures stability for standing installations.
- Sleek Design: Modern appearance.
- Compatible: Works with all Uni Clips and Uni Clip Signs.
- Matte Finish Options: Available in Black or White.
- Easy Setup: Simple assembly and deployment.

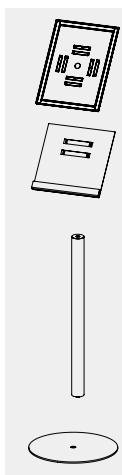
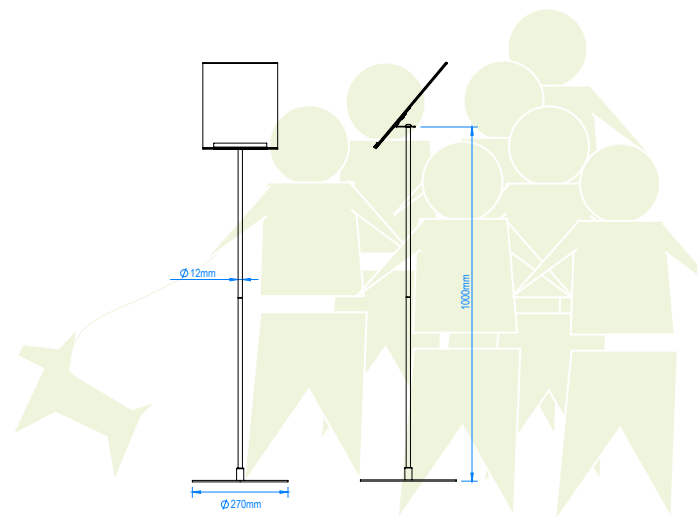
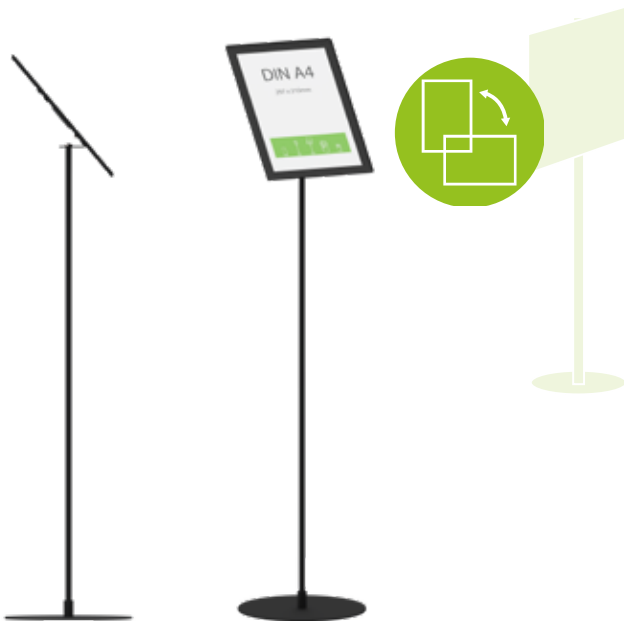

Item #	Item Description	PU	Outer Box			
			H (cm)	L (cm)	W (cm)	GW (kg)
03066	Info Frame, Black A4, with Mag Foil Black	10 in 1 Bulk Box	39	26	20	10
03086	Info Frame, White A4, with Mag Foil White	10 in 1 Bulk Box	39	26	20	10
02497	Uni Clip 15, 50°, Black	20 in 1 Box	20	39	39	7.5
03042	Uni Clip 15, 50°, White	20 in 1 Box	20	39	39	7.5
02643	Uni Clip 7.5, 50°, Black	40 in 1 Box	21	38	40	8.4
03043	Uni Clip 7.5, 50°, White	40 in 1 Box	21	38	40	8.4
02502	Instand Pole, 35, Black	100 in 1 Box	26	46	15	12.5
03039	Instand Pole, 35, White	100 in 1 Box	26	46	15	12.5
02503	Instand Pole, 48, Black	200 in 1 Box	29	55.5	25	25.5
03040	Instand Pole, 48, White	200 in 1 Box	29	55.5	25	25.5
02495	Instand Pole, 96 (2x48), Black	100 in 1 Box	27	55	29	26.5
03041	Instand Pole, 96 (2x48), White	100 in 1 Box	27	55	29	26.5
02494	Instand Base, 27Dia, Black	10 in 1 Bulk Box	13	28.5	28	19
03037	Instand Base, 27Dia, White	10 in 1 Bulk Box	13	28.5	28	19

# Tabletop and Counter Sign holders



Instand Base, 27Dia, Black + Instand Pole Tele, 50-96cm, Black



Instand Base, 15Sq + Instand Pole Tele, 25-43cm

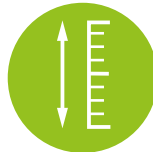

Instand Base, 27Dia, Black + Instand Pole Tele, 50-96cm



Instand Base, 15Sq + Instand Pole Tele, 25-43cm



## Instand Tele Info Stands

The Instand Tele Info Stands feature adjustable telescopic poles, available in two lengths—25 cm to 43 cm and 50 cm to 96 cm—allowing users to set the sign height according to their needs for 50° angled signs.

- **Adjustable Height:** Telescopic poles extend to desired heights for customized sign positioning.
- **50° Angled Display:** Enhances sign visibility.
- **Orientation Flexibility:** Info Frame allows easy switching between portrait and landscape orientations.
- **Stable Bases:**
  - Maxi: Comes with a round base for floor-standing stability.
  - Midi: Features square bases with center or top-centered holes, ideal for tables, counters, and shop racks.
- **Easy Setup:** Simple assembly and adjustment
- **Available in Black or White.**

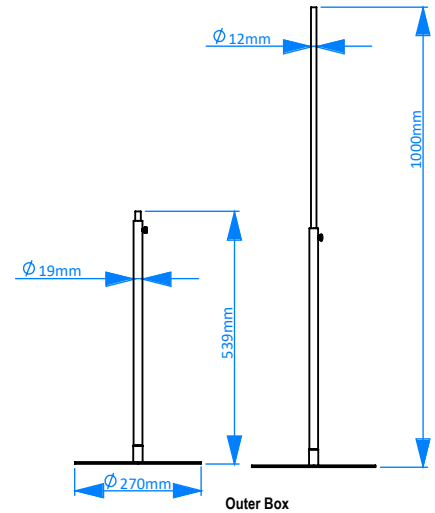

Outer Box

Item #	Item Description	PU	H (cm)	L (cm)	W (cm)	GW (kg)
03065	Info Frame, Black A3, with Mag Foil Black	10 in 1 Bulk Box	51	35	20	16
03066	Info Frame, Black A4, with Mag Foil Black	10 in 1 Bulk Box	39	26	20	10
03085	Info Frame, White A3, with Mag Foil White	10 in 1 Bulk Box	39	26	20	10
03086	Info Frame, White A4, with Mag Foil White	10 in 1 Bulk Box	39	26	20	10
02497	Uni Clip 15, 50°, Black	20 in 1 Box	20	39	39	7.5
03042	Uni Clip 15, 50°, White	20 in 1 Box	20	39	39	7.5
02643	Uni Clip 7.5, 50°, Black	40 in 1 Box	21	38	40	8.4
03043	Uni Clip 7.5, 50°, White	40 in 1 Box	21	38	40	8.4
02906	Instand Pole Tele, 25-43cm, Black	50 in 1 Box	12.5	28	23	9.5
03038	Instand Pole Tele, 25-43cm, White	50 in 1 Box	12.5	28	23	9.5
03088	Instand Pole Tele, 50-96cm, Black	50 in 1 Box	12.5	56	23	20
03087	Instand Pole Tele, 50-96cm, White	50 in 1 Box	12.5	56	23	20
02500	Instand Base, 15Sq, CTR, Black	20 in 1 Bulk Box	31	16	16	15
03035	Instand Base, 15Sq, CTR, White	20 in 1 Bulk Box	31	16	16	15
02501	Instand Base, 15Sq, TOP, Black	20 in 1 Bulk Box	31	16	16	15
03036	Instand Base, 15Sq, TOP, White	20 in 1 Bulk Box	31	16	16	15
02494	Instand Base, 27Dia, Black	10 in 1 Bulk Box	13	28.5	28	19
03037	Instand Base, 27Dia, White	10 in 1 Bulk Box	13	28.5	28	19

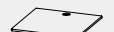
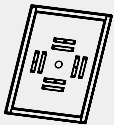

ADD A SIGN  
UNIVERSAL  
CLIP SIGN  
Page 57



## Instand Tele Sign Stands

The Instand Tele Sign Stands feature adjustable telescopic poles, available in two lengths—25 cm to 43 cm and 50 cm to 96 cm—allowing users to set the sign height according to their needs for straight signs.

- **Adjustable Height:** Telescopic poles extend to desired heights for customized sign positioning.
- **Straight Display:** Keeps signs upright for clear visibility.
- **Stable Bases:**
  - Maxi: Comes with a round base for floor-standing stability.
  - Midi: Features square bases with center or top-centered holes, ideal for tables, counters, and shop racks.
- **Easy Setup:** Simple assembly and adjustment.
- Available in Black or White.

Item #	Item Description	PU	Outer Box			
			H (cm)	L (cm)	W (cm)	GW (kg)
02837	Uni Frame, A3, Black. Incl. Pocket	10 in 1 Bulk Box	47.5	32	15.5	9.5
03059	Uni Frame, A3, White. Incl. Pocket	10 in 1 Bulk Box	47.5	32	15.5	9.5
02838	Uni Frame, A3L, Black. Incl. Pocket	10 in 1 Bulk Box	35.5	44	15.5	9.5
03058	Uni Frame, A3L, White. Incl. Pocket	10 in 1 Bulk Box	35.5	44	15.5	9.5
02836	Uni Frame, A4, Black. Incl. Pocket	10 in 1 Bulk Box	35.5	23	15.5	5
03060	Uni Frame, A4, White. Incl. Pocket	10 in 1 Bulk Box	35.5	23	15.5	5
02840	Uni Frame, A4L, Black. Incl. Pocket	10 in 1 Bulk Box	26.5	32	15.5	5
03061	Uni Frame, A4L, White. Incl. Pocket	10 in 1 Bulk Box	26.5	32	15.5	5
02835	Uni Frame, A5, Black. Incl. Pocket	10 in 1 Bulk Box	26.5	17	15.5	3
03062	Uni Frame, A5, White. Incl. Pocket	10 in 1 Bulk Box	26.5	17	15.5	3
02839	Uni Frame, A5L, Black. Incl. Pocket	10 in 1 Bulk Box	20.5	23	15.5	3
03063	Uni Frame, A5L, White. Incl. Pocket	10 in 1 Bulk Box	20.5	23	15.5	3
02727	Uni Clip Flex 10.5, Black	50 in 1 Box	16	33	28	4.8
03044	Uni Clip Flex 10.5, White	50 in 1 Box	16	33	28	4.8
00913	Uni Clip Flex 21, Black	50 in 1 Box	27	32	27	8
03045	Uni Clip Flex 21, White	50 in 1 Box	27	32	27	8
02510	Uni Clip, Alu, 10.5, Black	100 in 1 Box	25	29	22	8.5
03046	Uni Clip, Alu, 10.5, White	100 in 1 Box	25	29	22	8.5
02514	Uni Clip, Alu, 21, Black	100 in 1 Box	25	43	25	16.5
03047	Uni Clip, Alu, 21, White	100 in 1 Box	25	43	25	16.5
02906	Instand Pole Tele, 25-43cm, Black	50 in 1 Box	12.5	28	23	9.5
03038	Instand Pole Tele, 25-43cm, White	50 in 1 Box	12.5	28	23	9.5
03088	Instand Pole Tele, 50-96cm, Black	50 in 1 Box	12.5	56	23	20
03087	Instand Pole Tele, 50-96cm, White	50 in 1 Box	12.5	56	23	20
02500	Instand Base, 15Sq, CTR, Black	20 in 1 Bulk Box	31	16	16	15
03035	Instand Base, 15Sq, CTR, White	20 in 1 Bulk Box	31	16	16	15
02501	Instand Base, 15Sq, TOP, Black	20 in 1 Bulk Box	31	16	16	15
03036	Instand Base, 15Sq, TOP, White	20 in 1 Bulk Box	31	16	16	15
02494	Instand Base, 27Dia, Black	10 in 1 Bulk Box	13	28.5	28	19
03037	Instand Base, 27Dia, White	10 in 1 Bulk Box	13	28.5	28	19

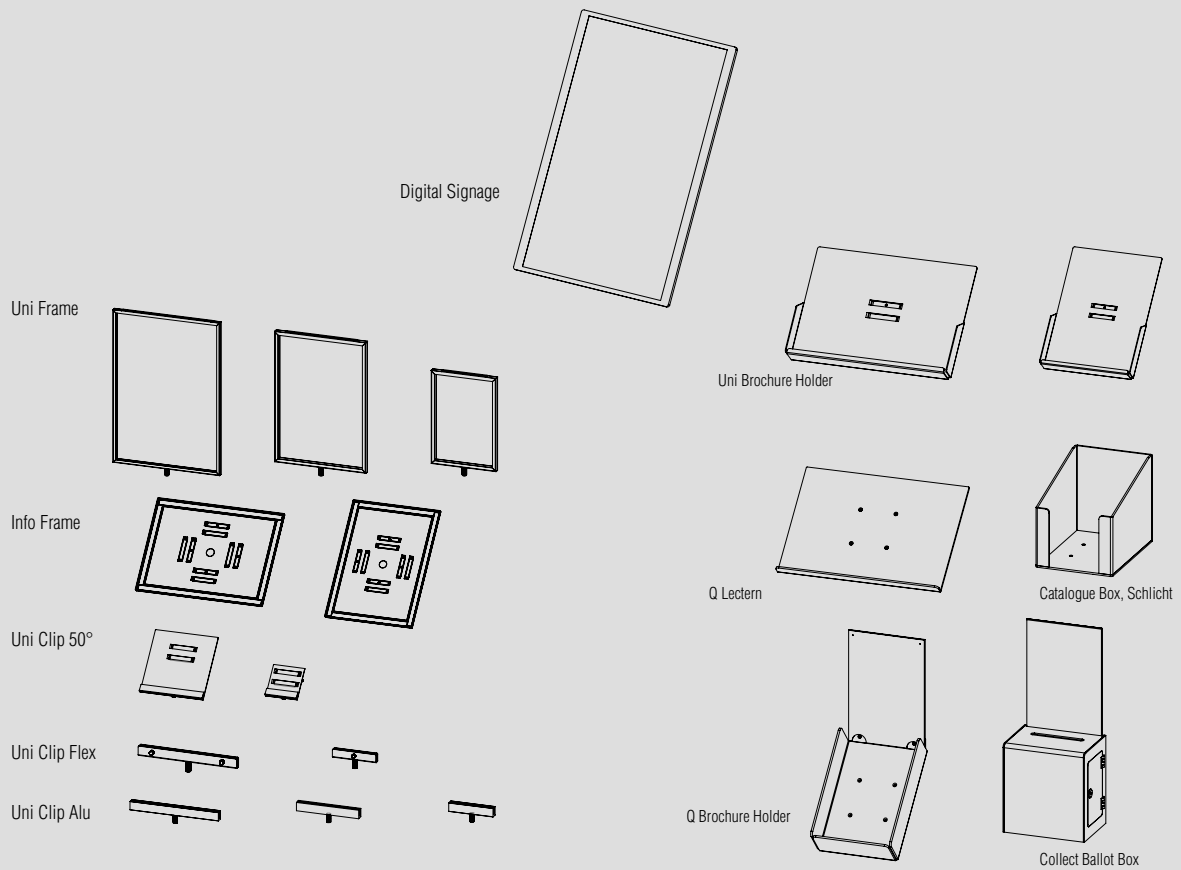

Crowd control: retractable or rope  
Page 115 to Page 117

Dispensers:  
Umbrella bag or gloves dispenser  
Page 118 to Page 119

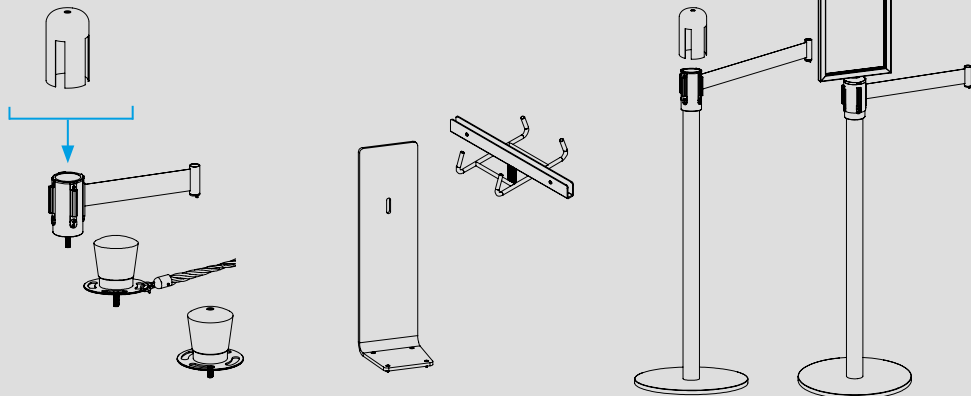

# Q EZI

Complete your display stands lineup with our versatile and robust Q EZI system.

Q EZI Pole 5.1  
Crowd Control

Q EZI Pole 3.8  
Signage

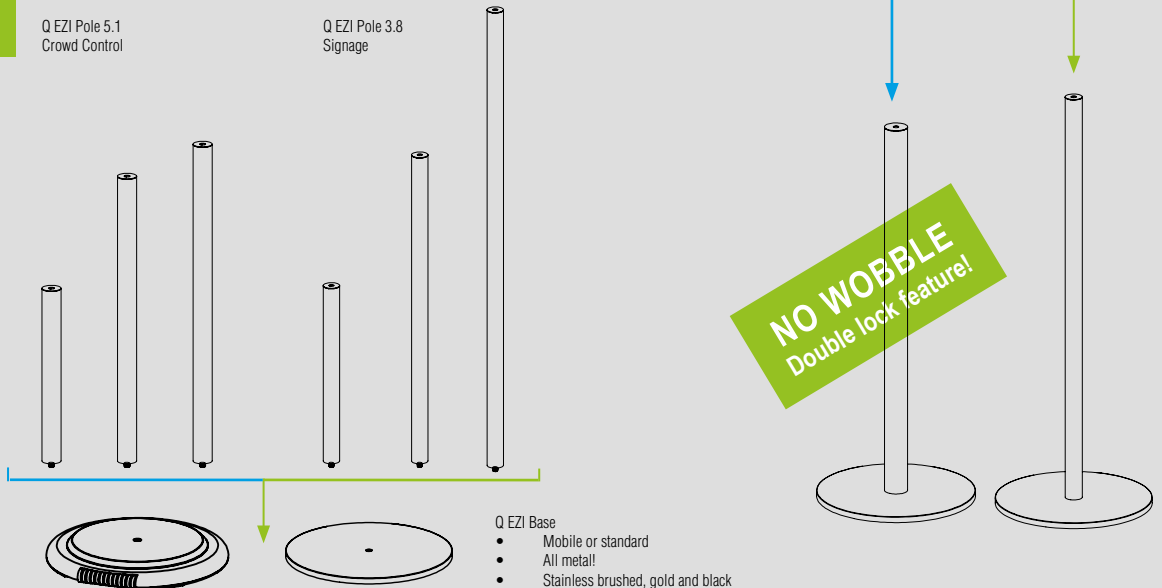



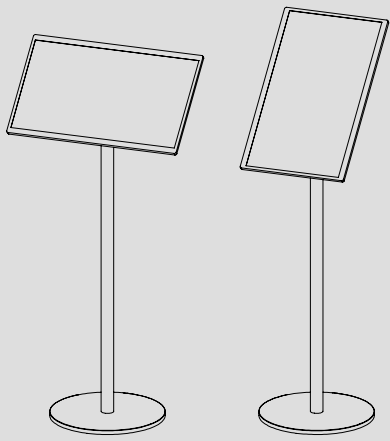

Digital Signage Page 22

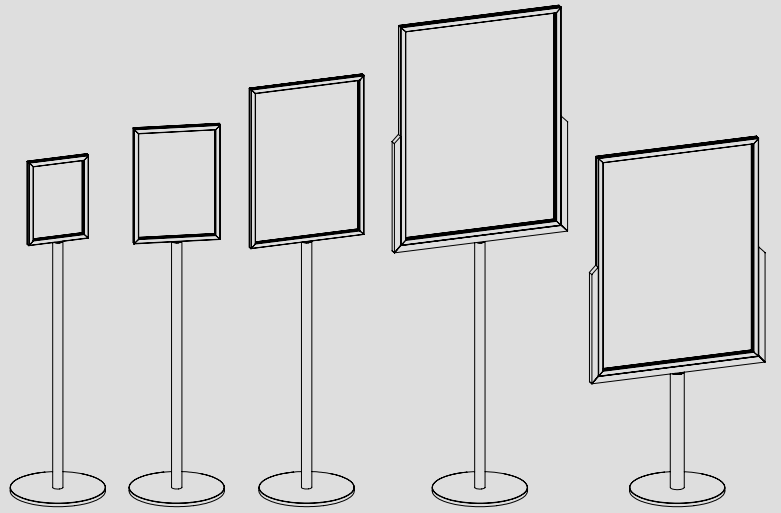

Q EZI Frame Page 21

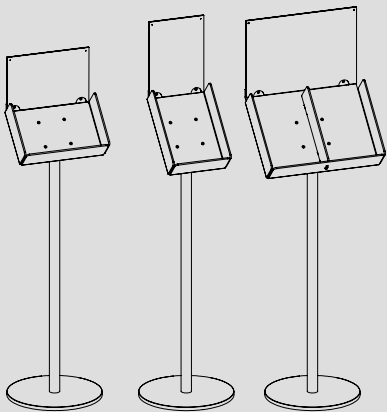

Q Brochure Holder Page 29

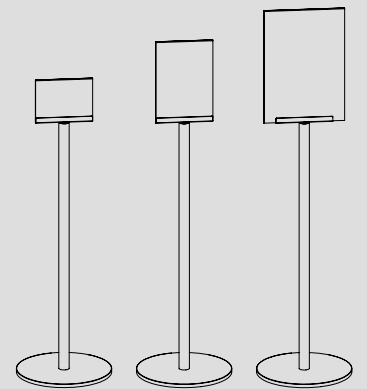
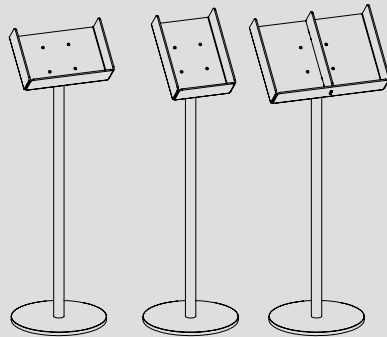

Q EZI Uni Clip Page 20

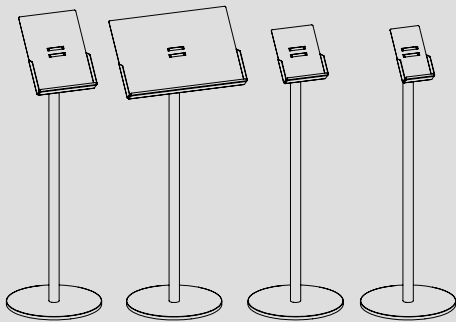

Q Uni Brochure Holder Page 28

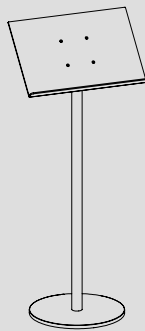

Q Lectern Page 30

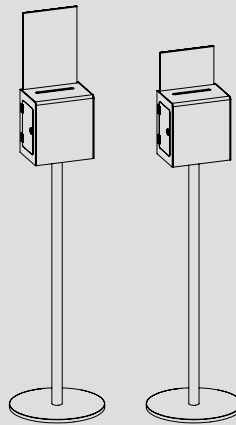

Collect Page 39

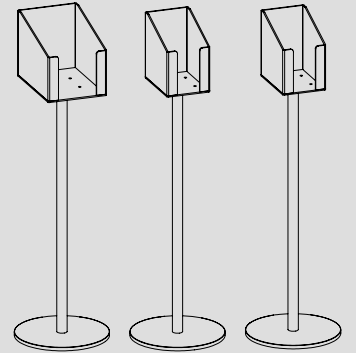

Q Schlicht Page 31

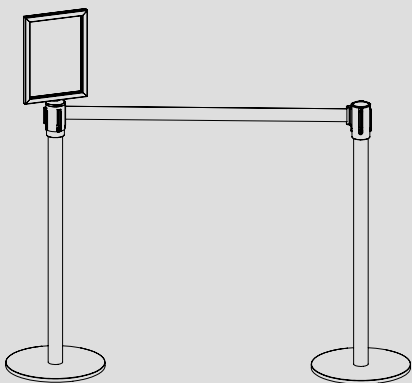

Crowd control: retractable or rope Page 115 to Page 117

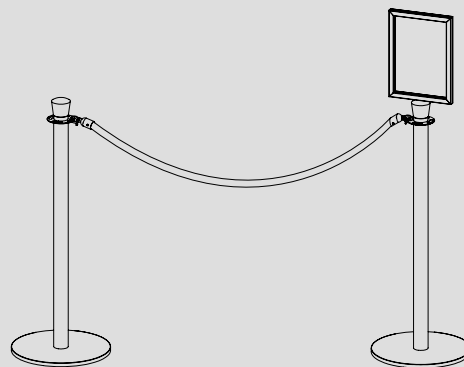

Q dispenser holder, Acric Page 118

# Floor Standing Frames & Sign Holders

## Q EZI



- Modular: this modular system enables various combinations, reducing order losses due to missing inventory.
- Stable structure: with double lock system to avoid wobbling
- Flexible: many possible combinations for crowd control and/or signage
- Easy assembly

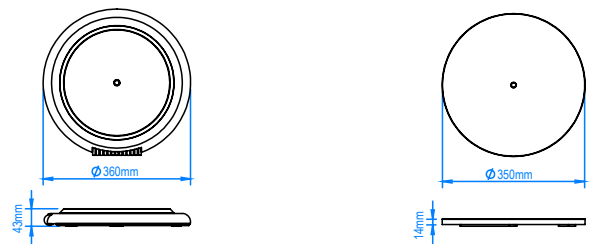
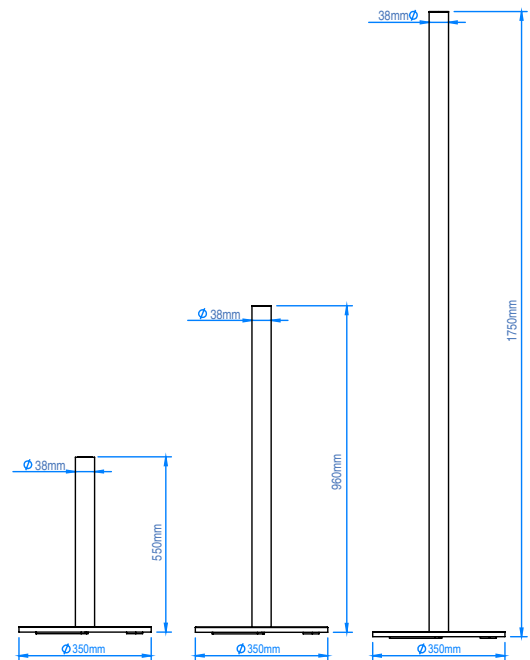

### Outer Box

Item #	Item Description	PU	H (cm)	L (cm)	W (cm)	GW (kg)
01333	Q EZI Pole 3.8 x 175 brushed	10 in 1 box	183	30	12	15.5
01332	Q EZI Pole 3.8 x 175 PC Black	10 in 1 box	183	30	12	15.5
02300	Q EZI Pole 3.8 x 55 brushed	10 in 1 Box	61	33	13	5
02301	Q EZI Pole 3.8 x 55 Gold	10 in 1 Box	61	33	13	5
02299	Q EZI Pole 3.8 x 55 PC Black	10 in 1 Box	61	33	13	5
01334	Q EZI Pole 3.8 x 96 brushed	10 in 1 Box	104	30	12	9.4
01359	Q EZI Pole 3.8 x 96 Gold	10 in 1 Box	104	30	12	9.4
01335	Q EZI Pole 3.8 x 96 PC Black	10 in 1 Box	104	30	12	9.4
01330	Q EZI base 35 Black	2 in 1 Box	8	42	42	19.5
01329	Q EZI base 35 Gold	2 in 1 Box	8	42	42	19.5
01331	Q EZI base 35 Stainless	2 in 1 Box	8	42	42	19.5
01372	Q EZI base ergo	2 in 1 Box	18	36	36	16

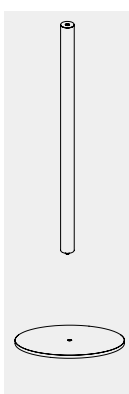

## Q EZI Info Stand

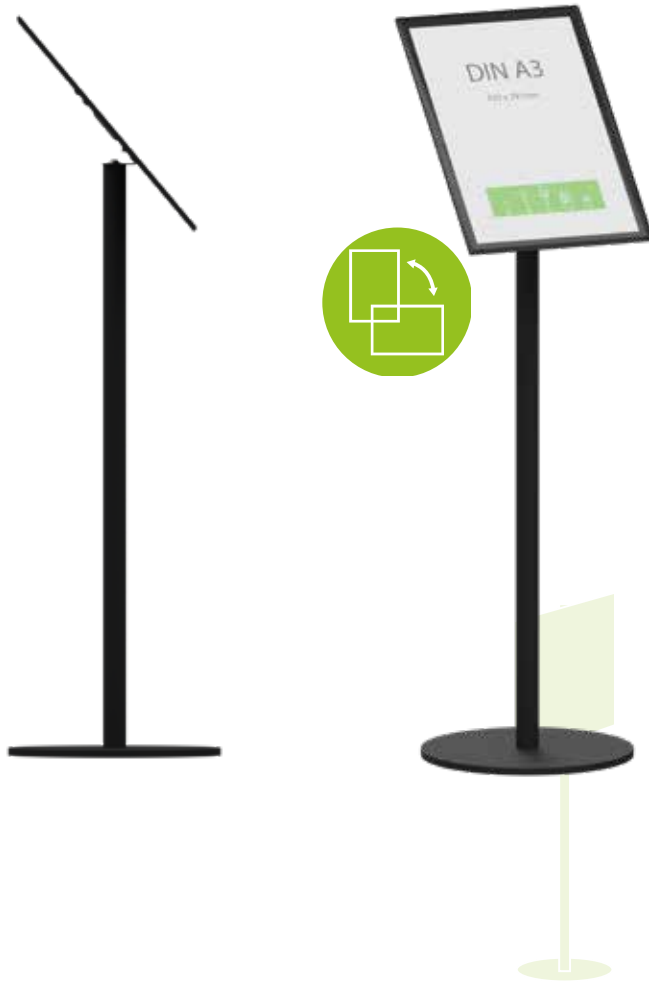

The Q EZI Stand with Info Frame features a sturdy design suitable for larger signs up to A3 size. With a 50° angled frame that supports both portrait and landscape orientations and our double-lock mechanism for a wobble-free display, it's ideal for high-traffic environments.

- **Heavy-Duty Construction:** Made from matte black coated stainless steel, weighing approximately 9 kg for stability.
- **Supports Larger Sizes:** Suitable for A3 posters and interchangeable with other formats.
- **50° Angled Display:** Enhances sign visibility at an optimal viewing angle.
- **Orientation Flexibility:** Info Frame allows easy switching between portrait and landscape orientations.
- **Modular System:** Based on the Q Stand system, compatible with other accessories like different sign sizes, barrier belts, and brochure holders.
- **Easy Assembly:** Simple and quick setup process.

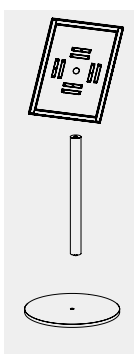

Item #	Item Description	PU	Outer Box			
			H (cm)	L (cm)	W (cm)	GW (kg)
03065	Info Frame, Black A3, with Mag Foil Black	10 in 1 Bulk Box	51	35	20	16
03066	Info Frame, Black A4, with Mag Foil Black	10 in 1 Bulk Box	39	26	20	10
01335	Q EZI Pole 3.8 x 96 PC Black	10 in 1 Box	104	30	12	9.4
01359	Q EZI Pole 3.8 x 96 Gold	10 in 1 Box	104	30	12	9.4
01334	Q EZI Pole 3.8 x 96 brushed	10 in 1 Box	104	30	12	9.4
01330	Q EZI base 35 Black	2 in 1 Box	8	42	42	19.5
01329	Q EZI base 35 Gold	2 in 1 Box	8	42	42	19.5
01331	Q EZI base 35 Stainless	2 in 1 Box	8	42	42	19.5

# Floor Standing Frames & Sign Holders

## Q EZI Uni Clip Flex

- Double sided: for images on both sides.
- For 5mm thick boards or with Uni Clip signs (Page 57)
- Fully compatible with our Q EZI crowd control
- Available in Stainless Brushed, Black and Gold

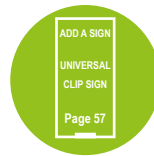

Item #	Item Description	PU	Outer Box			
			H (cm)	L (cm)	W (cm)	GW (kg)
00913	Uni Clip Flex 21, Black	50 in 1 Box	27	32	27	8
01274	Uni Clip Flex 21, Gold	50 in 1 Box	27	32	27	8
00853	Uni Clip Flex 21, Inox Brushed	50 in 1 Box	27	32	27	8
01334	Q EZI Pole 3.8 x 96 brushed	10 in 1 Box	104	30	12	9.4
01359	Q EZI Pole 3.8 x 96 Gold	10 in 1 Box	104	30	12	9.4
01335	Q EZI Pole 3.8 x 96 PC Black	10 in 1 Box	104	30	12	9.4
01330	Q EZI base 35 Black	2 in 1 Box	8	42	42	19.5
01329	Q EZI base 35 Gold	2 in 1 Box	8	42	42	19.5
01331	Q EZI base 35 Stainless	2 in 1 Box	8	42	42	19.5
<b>Uni Clips Signs</b>			<b>Outer Box</b>			
Item #	Item Description	PU	H (cm)	L (cm)	W (cm)	GW (kg)
00909	Uni Clip Sign A3	20 in 1 Bulk Box	47	33	23	16.5
00910	Uni Clip Sign A3L	20 in 1 Box	44	45.5	35	20.5
00907	Uni Clip Sign A4	30 in 1 Bulk Box	34	34	24	15
00908	Uni Clip Sign A4L	30 in 1 Bulk Box	34	34	24	15
00906	Uni Clip Sign A5L	50 in 1 Bulk Box	19	55	25	11

# Floor Standing Frames & Sign Holders

## Q EZI Frame

- Double sided: for images on both sides.
- Protection foils with black separator sheet.
- Fully compatible with our Q EZI crowd control
- Available in Stainless Brushed, Black and Gold

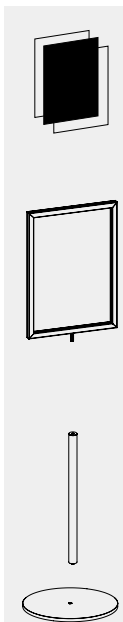
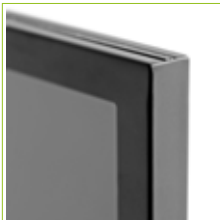

Item #	Item Description	PU	Outer Box			
			H (cm)	L (cm)	W (cm)	GW (kg)
00238	Q Frame protection sheet A2	10 in 1 Bulk Box	12	68	50	17
00239	Q Frame protection sheet A3	40 in 1 Bulk Box	21	50	38	9.4
00240	Q Frame protection sheet A4	50 in 1 Bulk Box	26	38	29	11.9
01148	Q Frame 30 x 40", brushed	10 in 1 box	58	115	92	5.5
01371	Q Frame A1, Black	10 in 1 Box	47	95	74	29
00758	Q Frame A1, brushed	10 in 1 Box	47	95	74	29
02673	Q Frame A2, Black Incl. Protection Sheet	10 in 1 Box	50	70	49	32
02676	Q Frame A2, brushed Incl. Protection Sheet	10 in 1 Box	50	70	49	32
02674	Q Frame A3, Black Incl. Protection Sheet	10 in 1 Box	47	53	36	14.5
02677	Q Frame A3, brushed Incl. Protection Sheet	10 in 1 box	47	53	36	14.5
02679	Q Frame A3, Gold Incl. Protection Sheet	10 in 1 box	47	53	36	14.5
02675	Q Frame A4, Black Incl. Protection Sheet	10 in 1 Box	41	48	28	9.5
02678	Q Frame A4, brushed Incl. Protection Sheet	10 in 1 Box	41	48	28	8.5
02300	Q EZI Pole 3.8 x 55 brushed	10 in 1 Box	61	33	13	5
02299	Q EZI Pole 3.8 x 55 PC Black	10 in 1 Box	61	33	13	5
01334	Q EZI Pole 3.8 x 96 brushed	10 in 1 Box	104	30	12	9.4
01335	Q EZI Pole 3.8 x 96 PC Black	10 in 1 Box	104	30	12	9.4
01330	Q EZI base 35 Black	2 in 1 Box	8	42	42	19.5
01331	Q EZI base 35 Stainless	2 in 1 Box	8	42	42	19.5



**Q EZI**



**Digital Signage Stand**

## Q EZI Digital Stand



Enhance your product lineup and meet the growing demand for digital signage solutions without technical hurdles and with manufacturer-backed screen warranties. Our modular and robust stand system enables you to offer digital displays with minimal effort—simply integrate any screen with a centered 10x10 cm VESA mount, like the Samsung QB24, and you're ready to go.

- Stable structure: our double-lock system, enables a wobble-free display
- Modular stand: ensuring you have the right setup for any application.
- Sturdy Base: A heavy-duty base ensures stability in high-traffic environments.
- Easy assembly
- Angled adapter for portrait and landscape orientation, optimal for touchscreen

	Item #	Item Description	PU	Outer Box			
				H (cm)	L (cm)	W (cm)	GW (kg)
	00409	Q Adapter 45 brushed	8 in 1 Box	21	28	25.5	3
	00879	Q Adapter 45 PC Black	8 in 1 Box	21	28	25.5	3
	01335	Q EZI Pole 3.8 x 96 PC Black	10 in 1 Box	104	30	12	9.4
	01359	Q EZI Pole 3.8 x 96 Gold	10 in 1 Box	104	30	12	9.4
	01334	Q EZI Pole 3.8 x 96 brushed	10 in 1 Box	104	30	12	9.4
	01330	Q EZI base 35 Black	2 in 1 Box	8	42	42	19.5
	01329	Q EZI base 35 Gold	2 in 1 Box	8	42	42	19.5
	01331	Q EZI base 35 Stainless	2 in 1 Box	8	42	42	19.5



## PLANAR DIGITAL

Digital signage solutions  
without technical hurdles

### **No Electronics Handling:**

Our stands are designed to hold digital screens from manufacturers like Samsung. You only need to stock the stands, not the electronic displays.

### **Lower Inventory Investment:**

By stocking only our affordable stands—you keep your inventory costs in check but can offer your customers a complete solution without needing to share profits with a full-solution supplier.

### **Manufacturer-Supported Warranties:**

You buy your screens from manufacturers like Samsung or their authorized distributors when you receive an order, the manufacturer handles all warranty and support for the electronics.

### **Easy Assembly:**

The stands are user-friendly and can be assembled by your customers with ease, reducing the need for technical support from your side.



Registered Design



## Planar Digital Signage Stands

The Planar Digital Signage Stands are robust and stable, made from thicker materials for increased durability compared to counterparts. Designed to hold Samsung digital signage screens, they can be modified to accommodate other brands based on customer demand. Easy to assemble and shipped flat-packed as parcels, they offer significant advantages over comparable products.

- **Lower Inventory Costs:** Stock the stands without investing in digital displays, reducing expenses. Quick delivery times are achievable since screens can be obtained from the Samsung distributor when orders are received.
- **Expand Product Range Easily:** Offer clients modern digital signage solutions without dealing with electronics or investing in expensive hardware. These affordable stands enable you to provide trending products while Samsung or other brands handle the electronic and software services.
- **Easy Assembly:** End-users can assemble the stands easily, minimizing the need for after-sale support.
- **Flat-Pack Shipping:** Ships flat-packed as parcels, saving on shipping costs and warehouse space.
- **Two Sizes Available:** Comes in 24" and 32" versions
- **Durable Finish:** Available in Black (with a rough, durable coating that's less prone to scratches and dirt) and White.

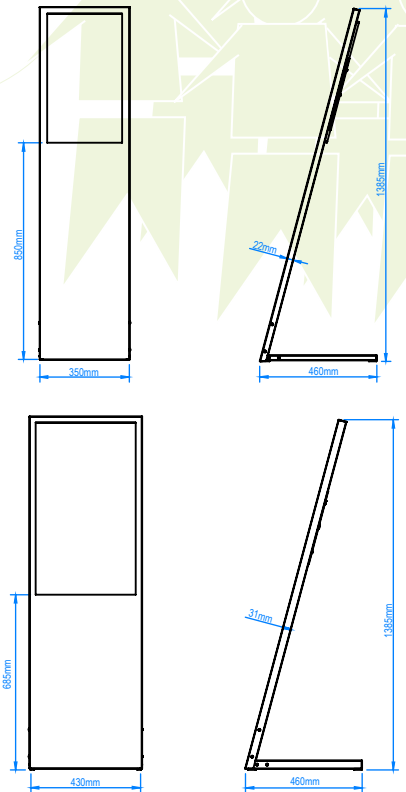

Item #	Item Description	PU	H (cm)	Outer Box			GW (kg)
				L (cm)	W (cm)		
03069	Planar Digital SAM24, Black	2 in 1 Box	148.5	39	17	21.5	
03070	Planar Digital SAM24, White	2 in 1 Box	148.5	39	17	21.5	
03080	Planar Digital SAM32, Black	2 in 1 Box	148.5	47	26	32	
03081	Planar Digital SAM32, White	2 in 1 Box	148.5	47	26	32	

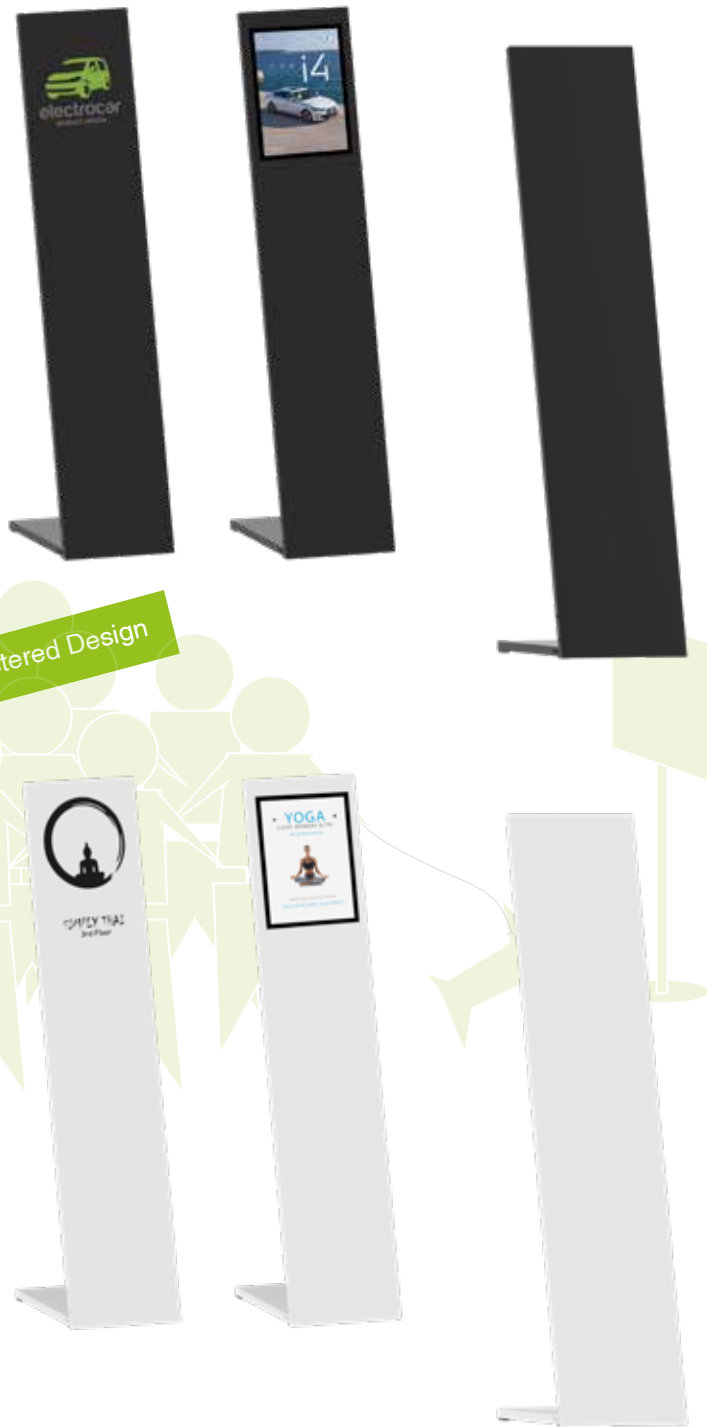

## Planar Info Stand

The Planar Information Stand combines elegance and functionality, offering a high-value display solution ideal for showcasing product information, branding, or schedules.

- **Modern and Durable Design:** Minimalist stand made from powder-coated galvanized steel for longevity and a sleek appearance.
- **Versatile Use:** Ideal for displaying data sheets next to machinery, cars, furniture, or for branding with logos—broadening your customer base.
- **Flexible and Customizable Display:** Supports multiple signs (up to 3 x A4). The matte, smooth powder-coated finish is perfect for direct surface printing, applying labels/foils or attaching printed magnetic foils—catering to various client needs and offering additional sales opportunities.
- **Easy Content Updates:** Includes an A4 magnetic frame (black; other colors available)
- **Space-Saving Packaging:** Ships flat-packed, optimizing warehouse space and reducing shipping costs.
- **Simple Assembly:** All parts and instructions included.
- **Color Options:** Black or White.

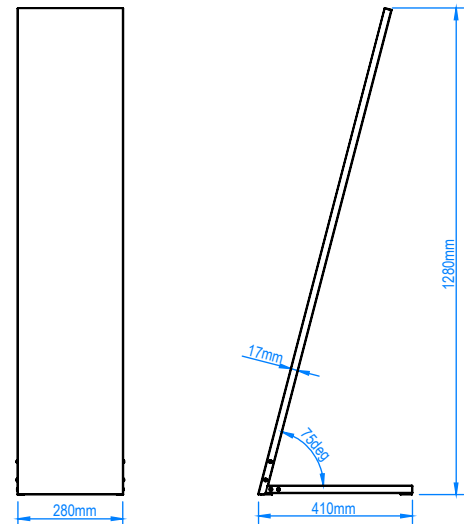

Item #	Item Description	PU	Outer Box			
			H (cm)	L (cm)	W (cm)	GW (kg)
03032	Planar Info Stand Black, 1x A4 Black	2 in 1 Box	141	32	17	14.6
03033	Planar Info Stand White, 1x A4 Black	2 in 1 Box	141	32	17	14.6
02777	Planar Info Stand, Black	2 in 1 Box	141	32	17	14.5
02778	Planar Info Stand, White	2 in 1 Box	141	32	17	14.5
03025	Mag Foil A4, Black, PVC	100 in 1 Box	24	42	33	10
03027	Mag Foil A4, Silver, PVC	100 in 1 Box	24	42	33	10
03026	Mag Foil A4, White, PVC	100 in 1 Box	24	42	33	10

## Planar 6x Brochure Stand

The Planar6x Brochure Stand offers a minimalist and straightforward design, crafted from high-quality powder-coated steel. It's an elegant solution for displaying brochures prominently.

- **Space-Saving Packaging:** Ships flat-packed to reduce storage and shipping costs.
- **Versatile Design:** Clean lines fit various environments.
- **Durable and Attractive:** Powder-coated galvanized steel ensures longevity and a sleek appearance.
- **Flexible Capacity:** Holds 6 x A4 brochures; includes dividers for up to 12 DL-size compartments.
- **Optional Acrylic Inserts:** Prevent thin brochures from tipping forward.
- **Branding Opportunity:** Space available for logo placement or direct printing.
- **Color Options:** Silver, Black, White, Gray RAL 7043.

Registered Design

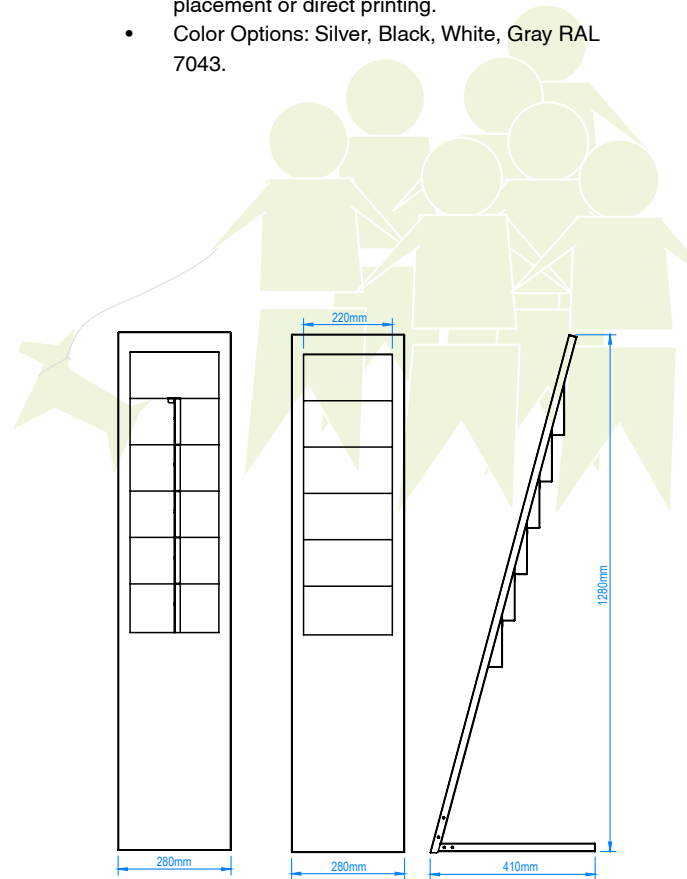

Item #	Item Description	PU	Outer Box			GW (kg)
			H (cm)	L (cm)	W (cm)	
02672	Planar 6x, Black	2 in 1 Box	16	141	34	19
02605	Planar 6x, RAL 7043	2 in 1 Box	16	141	34	19
02604	Planar 6x, Silver	2 in 1 Box	16	141	34	19
02912	Planar 6x, White	2 in 1 Box	16	141	34	19
02607	Planar 6x, Divider, RAL 7043	24 in 1 Box	27	42	28	10.5
02606	Planar 6x, Divider, Silver	24 in 1 Box	27	42	28	10.5

# Floor Standing Brochure & Literature Holders



## Q EZI Uni Brochure Holder

- Metal brochure holder for our Q EZI system
- Slim edge design enables complete display of brochures.
- Available in black or brushed stainless steel
- Mounting adapter available for single side or back to back mount.



Item #	Item Description	PU	Outer Box			
			H (cm)	L (cm)	W (cm)	GW (kg)
02520	Uni Brochure Holder, 2xA4/A3L, Black	10 in 1 Bulk Box	32	40	47.5	22
02521	Uni Brochure Holder, 2xA4/A3L, Brushed	10 in 1 Bulk Box	32	40	47.5	20.5
02517	Uni Brochure Holder, A4, Black	10 in 1 Bulk Box	32	40	24.5	12
02522	Uni Brochure Holder, A4, Brushed	10 in 1 Bulk Box	32	40	24.5	11.5
02583	Uni Brochure Holder, A4L, Black	10 in 1 Bulk Box	23.5	40	32.5	12
02584	Uni Brochure Holder, A4L, Brushed	10 in 1 Bulk Box	23.5	40	32.5	12
02518	Uni Brochure Holder, A5, Black	20 in 1 Bulk Box	23	40	36	14
02523	Uni Brochure Holder, A5, Brushed	20 in 1 Bulk Box	23	40	36	12.5
02519	Uni Brochure Holder, DL/A6, Black	20 in 1 Bulk Box	23	40	26	10.5
02524	Uni Brochure Holder, DL/A6, Brushed	20 in 1 Bulk Box	23	40	26	10
01334	Q EZI Pole 3.8 x 96 brushed	10 in 1 Box	104	30	12	9.4
01335	Q EZI Pole 3.8 x 96 PC Black	10 in 1 Box	104	30	12	9.4
01337	Q EZI Pole 5.1 x 85 brushed	10 in 1 Box	92	36	15	11
01339	Q EZI Pole 5.1 x 85 PC Black	10 in 1 Box	92	36	15	11
01330	Q EZI base 35 Black	2 in 1 Box	8	42	42	19.5
01331	Q EZI base 35 Stainless	2 in 1 Box	8	42	42	19.5

# Floor Standing Brochure & Literature Holders



## Q EZI Brochure Holder

- Acrylic brochure holder for our Q EZI system
- Available with or without sign



Item #	Item Description	PU	Outer Box			GW (kg)
			H (cm)	L (cm)	W (cm)	
00847	Q Brochure Holder divider 2xA5 for A4L	40 in 1 Box	68	69	45	9
00846	Q Brochure Holder divider 3xDL for A4L	40 in 1 Box	68	69	45	10
01300	Q Brochure Holder divider 4xDL for 2xA4	30 in 1 Bulk Box	46	59	48	11.5
00821	Q Brochure holder Sign, A3L PETG	20 in 1 Box	35	48	63	20
00822	Q Brochure holder Sign, A4, PETG	40 in 1 Box	34	78	46	18
00842	Q Brochure holder Sign, A4L, PETG	40 in 1 Box	34	72	48	19
01376	Q Brochure holder 2xA4, with A3L sign	5 in 1 Bulk Box	40	50	48	11
01375	Q Brochure holder A4, with A4 sign	10 in 1 Box	38	52.5	50.5	12
01377	Q Brochure holder A4L, with A4L sign	5 in 1 Bulk Box	40	55.5	48.5	9
00426	Q Brochure holder 2xA4	10 in 1 Box	50	52	78	19
00425	Q Brochure holder A4	10 in 1 Box	38	52.5	50.5	12
01374	Q Brochure holder A4L	10 in 1 Box	18	112	35	12
00409	Q Adapter 45 brushed	8 in 1 Box	21	28	25.5	3
00879	Q Adapter 45 PC Black	8 in 1 Box	21	28	25.5	3
01335	Q EZI Pole 3.8 x 96 PC Black	10 in 1 Box	104	30	12	9.4
01359	Q EZI Pole 3.8 x 96 Gold	10 in 1 Box	104	30	12	9.4
01334	Q EZI Pole 3.8 x 96 brushed	10 in 1 Box	104	30	12	9.4
01330	Q EZI base 35 Black	2 in 1 Box	8	42	42	19.5
01329	Q EZI base 35 Gold	2 in 1 Box	8	42	42	19.5
01331	Q EZI base 35 Stainless	2 in 1 Box	8	42	42	19.5

# Floor Standing Brochure & Literature Holders

## Q Lectern

- Freestanding magazine or menu holder
- Top 4.5mm Acrylic
- Ideal for displaying brochures in shops or menus in restaurant
- A 2.5cm lip holds items securely on top
- Fully compatible with our Q EZI system

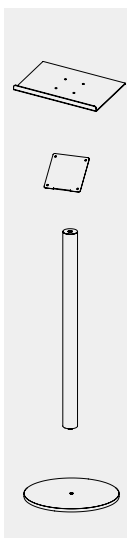
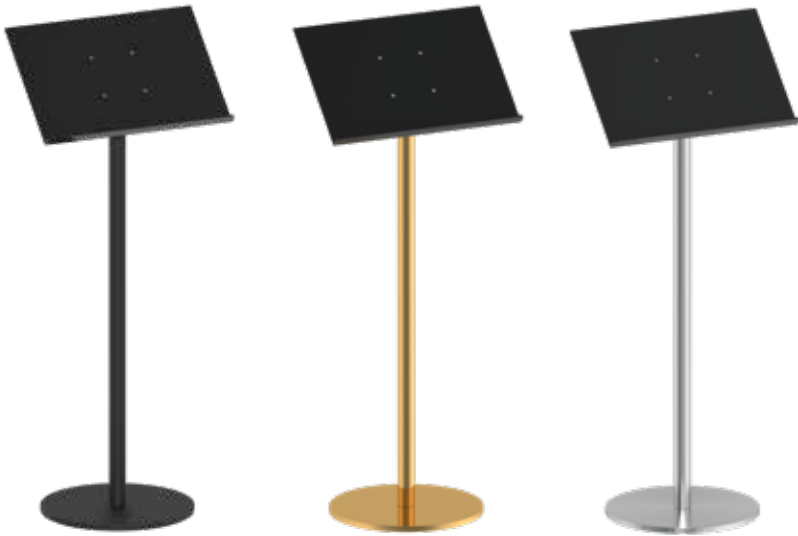

Item #	Item Description	PU	Outer Box			
			H (cm)	L (cm)	W (cm)	GW (kg)
02374	Q Lectern A3, Black	10 in 1 Bulk Box	15	43	40	9.3
02373	Q Lectern A3, Clear	10 in 1 Bulk Box	15	43	40	9.3
00409	Q Adapter 45 brushed	8 in 1 Box	21	28	25.5	3
00879	Q Adapter 45 PC Black	8 in 1 Box	21	28	25.5	3
01334	Q EZI Pole 3.8 x 96 brushed	10 in 1 Box	104	30	12	9.4
01359	Q EZI Pole 3.8 x 96 Gold	10 in 1 Box	104	30	12	9.4
01335	Q EZI Pole 3.8 x 96 PC Black	10 in 1 Box	104	30	12	9.4
01337	Q EZI Pole 5.1 x 85 brushed	10 in 1 Box	92	36	15	11
01338	Q EZI Pole 5.1 x 85 Gold	10 in 1 Box	92	36	15	11
01339	Q EZI Pole 5.1 x 85 PC Black	10 in 1 Box	92	36	15	11
01330	Q EZI base 35 Black	2 in 1 Box	8	42	42	19.5
01329	Q EZI base 35 Gold	2 in 1 Box	8	42	42	19.5
01331	Q EZI base 35 Stainless	2 in 1 Box	8	42	42	19.5

# Floor Standing Brochure & Literature Holders

## Q Schlicht

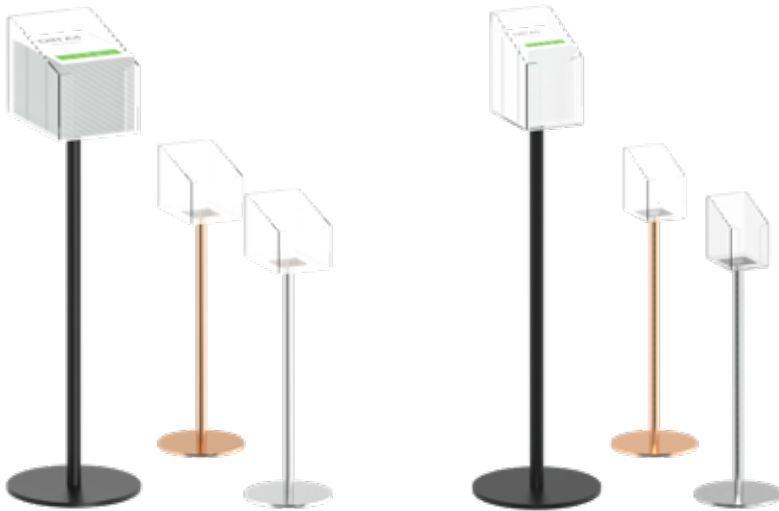

- Freestanding catalogue dispenser
- Top quality, clear acrylic
- Ideal for dispensing catalogue in shops .
- Fully compatible with our Q EZI system

Item #	Item Description	PU	Outer Box			
			H (cm)	L (cm)	W (cm)	GW (kg)
02406	Catalogue Box, Schlicht, A4, Clear	1 in 1 Box	28	34	25	2.5
02569	Catalogue Box, Schlicht, A5, Clear	1 in 1 Box	28	26	19	1.7
00414	Q Adapter 0°, brushed	50 in 1 Box	29.5	42	28.5	12.5
01335	Q EZI Pole 3.8 x 96 PC Black	10 in 1 Box	104	30	12	9.4
01359	Q EZI Pole 3.8 x 96 Gold	10 in 1 Box	104	30	12	9.4
01334	Q EZI Pole 3.8 x 96 brushed	10 in 1 Box	104	30	12	9.4
01330	Q EZI base 35 Black	2 in 1 Box	8	42	42	19.5
01329	Q EZI base 35 Gold	2 in 1 Box	8	42	42	19.5
01331	Q EZI base 35 Stainless	2 in 1 Box	8	42	42	19.5

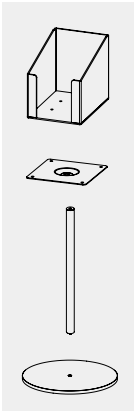

## Brochure Stand Mesh

- Metal mesh brochure holder.
- Allows easy access and complete view to brochures
- made of powder coated steel



Item #	Item Description	PU	Outer Box			
			H (cm)	L (cm)	W (cm)	GW (kg)
02323	Brochure stand Mesh L4 12	6 in 1 Box	33	82	64	30
01267	Brochure stand Mesh L4 4	6 in 1 Box	33	82	37	24
01268	Brochure stand Mesh L4 8	6 in 1 Box	33	82	64	28



## Shieldbox

Outdoor Brochure Holder



## Shieldbox

Registered Design

- Wall brochure holder with lid for outdoor use
- For format A4, A5 and DL
- 5cm depth on the normal size, 10cm on XL
- Bottom, back and lid made of galvanized steel with powder coating.
- Front and sides made of 3mm, UV and impact-resistant polycarbonate.
- Including screws and anchors for wall mount



Item #	Item Description	PU	Outer Box			
			H (cm)	L (cm)	W (cm)	GW (kg)
02113	Shieldbox Brochure Holder A4	10 in 1 Box	37	42	52	19.5
02702	Shieldbox Brochure Holder A4L	5 in 1 Box	30	42	38	11
02112	Shieldbox Brochure Holder A5	10 in 1 Box	29	43	39	11
02700	Shieldbox Brochure Holder A6	10 in 1 Box	22.5	42	30	7.4
02701	Shieldbox Brochure Holder A6L	10 in 1 Box	19.5	42	39.5	8.3
02111	Shieldbox Brochure Holder DL	10 in 1 Box	29	42	31	8.6
02320	Shieldbox Brochure Holder A4 XL	8 in 1 Box	37	54	52	18
02321	Shieldbox Brochure Holder DL XL	8 in 1 Box	29	54	30	10.5

# Wall Brochure & Literature Holders

## Cove



- Weather resistant outdoor brochure holder with lid
- With holes for wall mount
- Flat back, enabling double sided tape mounting
- Superb workmanship
- Made of 3 mm clear acrylic
- 3cm space for brochures
- Equipped with a easy-to-open transparent lid

Item #	Item Description
02927	Cove 2.0, A4
02929	Cove 2.0, A5
02930	Cove 2.0, A6
02931	Cove 2.0, A6L
02933	Cove 2.0, DL
02932	Cove 2.0, BC

PU	Outer Box			
	H (cm)	L (cm)	W (cm)	GW (kg)
20 in 1 Box	41	73	53	22.5
40 in 1 Box	57	73	41	25
60 in 1 Box	45	73	49	25
60 in 1 Box	36	73	60	26
60 in 1 Box	58	73	46	28
50 in 1 Box	14	60	53	7

## Cove 3in1



- Weather resistant outdoor brochure holder with lid
- With holes for wall mount
- flat back, enabling double sided tape mounting
- Superb workmanship
- Made of 3 mm clear acrylic (PMMA)
- 3cm space for brochures
- Including separators for usage as 3xDL, 2xA5 or A4 landscape

Item #	Item Description
02928	Cove 2.0, A4L 2xA5, 3xDL

PU	Outer Box			
	H (cm)	L (cm)	W (cm)	GW (kg)
20 in 1 Box	56	73	38	22



## Cove XL

- Weather resistant outdoor brochure holder with lid
- With holes for wall mount
- Flat back, enabling double sided tape mounting
- Superb workmanship
- DL made of 3 mm clear acrylic, A4 made of 5mm clear acrylic.
- Space for brochures: DL 7cm, A4 10cm



Item #	Item Description	PU	Outer Box			
			H (cm)	L (cm)	W (cm)	GW (kg)
02969	Cove 2.0, A4 XL	10 in 1 Box	40	68	53.5	18
02970	Cove 2.0, DL XL	40 in 1 Box	58	61	51	23



## Cove Accessories

- For A Board attachment
- For Car attachment

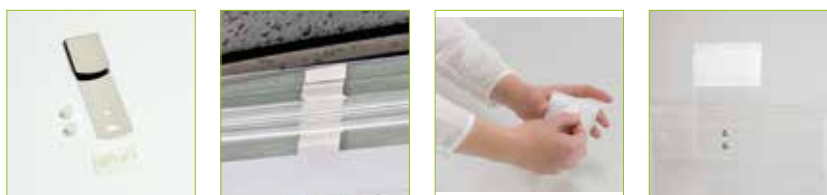

Item #	Item Description	PU	Outer Box			
			H (cm)	L (cm)	W (cm)	GW (kg)
00757	Cove A-BoardFix Pro	200 in 1 Bulk Box	20	25	15	9
00201	Cove CarFix	100 in 1 Bulk Box	13	19.5	11	1.3
02385	Cove L bracket	50 in 1 Bulk Box	6	28	15	1.3

# Wall Brochure & Literature Holders

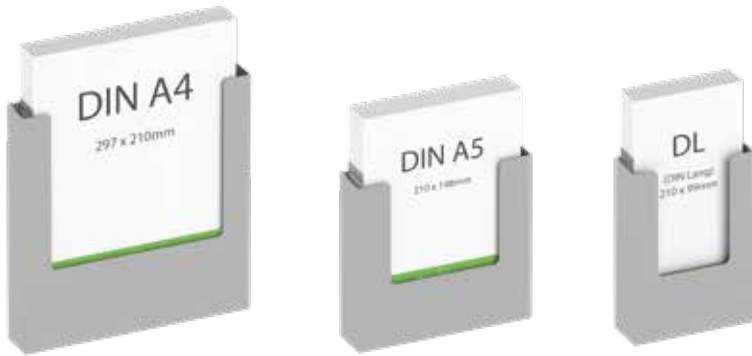

## Wall Brochure Holder, GS

- Made of galvanized steel with powder coating
- For wall or pole mount
- Compatible with aluminum pole systems

Item #	Item Description	PU	Outer Box			
			H (cm)	L (cm)	W (cm)	GW (kg)
00875	Wall Brochure Holder, GS A3L Silver	5 in 1 Box	46	25	29	7.8
00741	Wall Brochure Holder, GS A4 Silver	5 in 1 Box	36	25	29	4.5
00743	Wall Brochure Holder, GS A5 Silver	10 in 1 Box	24.5	36	20	5.5
00742	Wall Brochure Holder, GS DL Silver	10 in 1 Box	25	25	20	4.2

## Uni Brochure Holder

- Stable construction made of steel with powder coating or stainless steel.
- For angled wall mount to display brochures.
- Compatible with aluminum pole systems
- Compatible with Q EZI system



Item #	Item Description	PU	Outer Box			
			H (cm)	L (cm)	W (cm)	GW (kg)
02520	Uni Brochure Holder, 2xA4/A3L, Black	10 in 1 Bulk Box	32	40	47.5	22
02521	Uni Brochure Holder, 2xA4/A3L, Brushed	10 in 1 Bulk Box	32	40	47.5	20.5
02579	Uni Brochure Holder, 2xA4/A3L, Silver	10 in 1 Bulk Box	32	40	47.5	22
02517	Uni Brochure Holder, A4, Black	10 in 1 Bulk Box	32	40	24.5	12
02522	Uni Brochure Holder, A4, Brushed	10 in 1 Bulk Box	32	40	24.5	11.5
02580	Uni Brochure Holder, A4, Silver	10 in 1 Bulk Box	32	40	24.5	12
02583	Uni Brochure Holder, A4L, Black	10 in 1 Bulk Box	23.5	40	32.5	12
02584	Uni Brochure Holder, A4L, Brushed	10 in 1 Bulk Box	23.5	40	32.5	12
02585	Uni Brochure Holder, A4L, Silver	10 in 1 Bulk Box	23.5	40	32.5	12
02518	Uni Brochure Holder, A5, Black	20 in 1 Bulk Box	23	40	36	14
02523	Uni Brochure Holder, A5, Brushed	20 in 1 Bulk Box	23	40	36	12.5
02581	Uni Brochure Holder, A5, Silver	20 in 1 Bulk Box	23	40	36	14
02519	Uni Brochure Holder, DL/A6, Black	20 in 1 Bulk Box	23	40	26	10.5
02524	Uni Brochure Holder, DL/A6, Brushed	20 in 1 Bulk Box	23	40	26	10
02582	Uni Brochure Holder, DL/A6, Silver	20 in 1 Bulk Box	23	40	26	10.5



## Sorti

- Great workmanship
- Durable made of galvanized steel with powder coating
- Mounts on walls
- 20 pocket units can be free standing or wall mounted

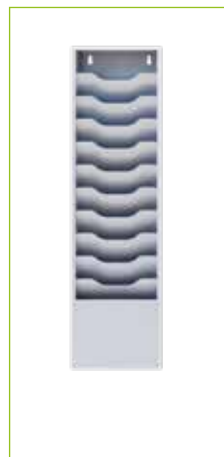
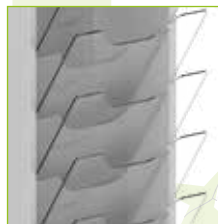
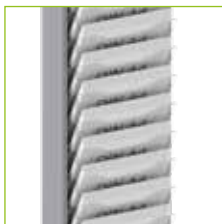

Item #	Item Description	PU	Outer Box			
			H (cm)	L (cm)	W (cm)	GW (kg)
00401	Sorti 11 slim RAL 9006	1 in 1 Box	12	96	30	7.2
00404	Sorti 11 wide RAL 9006	1 in 1 Box	12	96	48	11
00402	Sorti 20 slim RAL 9006	1 in 1 Box	12	153	28	12.3
00403	Sorti 20 wide RAL 9006	1 in 1 Box	12	153	48	18
00438	Sorti Swivel Set					
00415	Sorti base 35	2 in 1 Box	8	42	42	19.2
00436	Sorti Swivel pole for Q Base	2 in 1 Box	42	28	28	6.27
00437	Sorti x4 covers	4 in 1 Box	14	39	42	13.6

# Collect

Suggestion Box



# Suggestion, Ballot & Donation Boxes

## Collect

- Universal usage: table / counter top placement, wall mount, freestanding with our Q EZI system
- Modular A5L or A4 Uni Clip Sign compatible, A4 landscape sign on Collect XL
- With pen holder and/or leaflet holder
- Lockable



Item #	Item Description	PU	Outer Box			
			H (cm)	L (cm)	W (cm)	GW (kg)
02601	Collect Ballot Box XL, Clear	1 in 1 Box	35	36	35	2.5
02602	Collect Ballot Box XL, Clear Black	1 in 1 Box	35	36	35	2.5
02603	Collect Ballot Box XL, Frost White	1 in 1 Box	35	36	35	2.5
02157	Collect Ballot Box, Clear	8 in 1 Box	57	58.5	40	8.5
02135	Collect Ballot Box, Clear Black	8 in 1 Box	57	58.5	40	8.5
02134	Collect Ballot Box, Frost White	8 in 1 Box	57	58.5	40	8.5

# Suggestion, Ballot & Donation Boxes



## Karpas

- Metal drop box made of galvanized steel with powder coating.
- Ideal for inter office mailbox, suggestions or keys
- Lockable with triangle key
- Including accessories for wall mount
- Outdoor safe

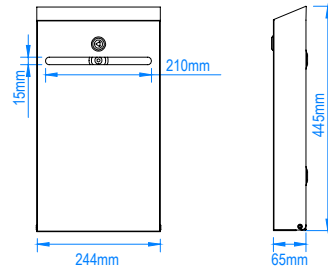

Item #	Item Description	Outer Box				
		PU	H (cm)	L (cm)	W (cm)	GW (kg)
02660	Karpas, Black	4 in 1 Box	34	49.5	27.5	12.2
02661	Karpas, Silver	4 in 1 Box	34	49.5	27.5	12.2

## Karpas Curved

- Metal drop Box made of galvanized steel with powder coating.
- Ideal for inter office mailbox, suggestions or keys
- Lockable with triangle key
- With A4 clear window for advertising, instructions or to make content visible
- Including accessories for wall mount
- Outdoor safe

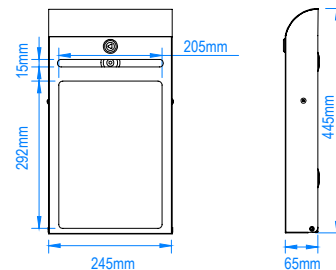

Item #	Item Description	Outer Box				
		PU	H (cm)	L (cm)	W (cm)	GW (kg)
00475	Karpas AD Curved, Black	4 in 1 Box	34	49.5	27.5	12.2
00605	Karpas AD Curved, Silver	4 in 1 Box	34	49.5	27.5	12.2



## Karpas Tabletop



- Metal donation or suggestion box made of galvanized steel with powder coating.
- Lockable
- For tabletop or counters

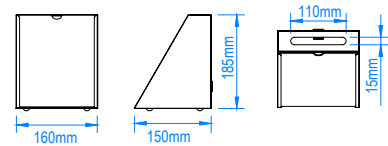

Item #	Item Description	PU	Outer Box			
			H (cm)	L (cm)	W (cm)	GW (kg)
01252	Karpas Tabletop A5, Black	4 in 1 Box	35	37	24	4
02410	Karpas Tabletop A5, Silver	4 in 1 Box	35	37	24	4

## Dime Donation Box



- Metal donation box
- Lockable
- Including chain
- Compatible with Uni Clip signs (not included)

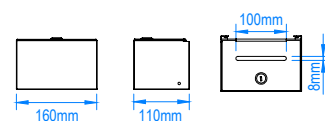

Item #	Item Description	PU	Outer Box			
			H (cm)	L (cm)	W (cm)	GW (kg)
00763	Dime Coin box, White	8 in 1 Box	26	37	26	6.8
02454	Dime Coin box, Silver	8 in 1 Box	26	37	26	6.8
02453	Dime Coin box, Black	8 in 1 Box	26	37	26	6.8



## Tabletop and Counter

Brochure holders

# Tabletop and Counter Brochure holders



## Tokio

- Superb workmanship with 3 mm acrylic
- Clear or frosted-white semitransparent acrylic
- 4cm space for brochures.
- Can be disassembled – easy to ship and store.

Item #	Item Description	PU	Outer Box			
			H (cm)	L (cm)	W (cm)	GW (kg)
00826	TOKIO A4 Clear	40 in 1 Box	38	63	53	22
00158	TOKIO A4 White	40 in 1 Box	38	63	53	25
00825	TOKIO A5 Clear	40 in 1 Box	33	54	43	13
00157	TOKIO A5 White	40 in 1 Box	33	54	43	18
00823	TOKIO DL Clear	60 in 1 Box	48	54	31	20
00156	TOKIO DL White	60 in 1 Box	48	54	31	20
00824	TOKIO screw sets	20 in 1 Bulk Box	18	25	20	



## Schlicht

- Catalogue Dispenser made of high quality 5mm Acrylic
- For Tabletop or counter tops
- Compatible with Q EZI System

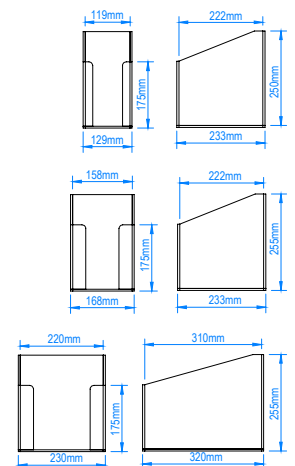
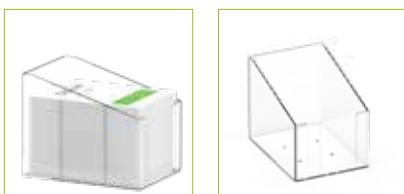

Item #	Item Description	PU	Outer Box			
			H (cm)	L (cm)	W (cm)	GW (kg)
02406	Catalogue Box, Schlicht, A4, Clear	1 in 1 Box	28	34	25	2.5
02569	Catalogue Box, Schlicht, A5, Clear	1 in 1 Box	28	26	19	1.7
02570	Catalogue Box, Schlicht, DL, Clear	1 in 1 Box	29	26	15	1.5

**WUDI**

Tabletop and Counter Brochure holder



# Tabletop and Counter Brochure holders



## Wudi

Registered Design

- Made of sustainable material
- Easy to assemble, no tools needed
- Flat package for easy storage and reduction of transport damages,

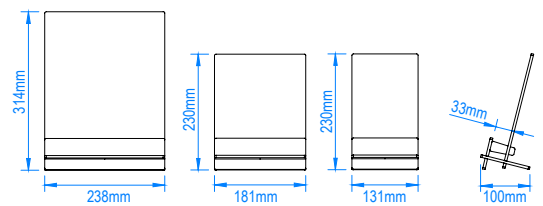
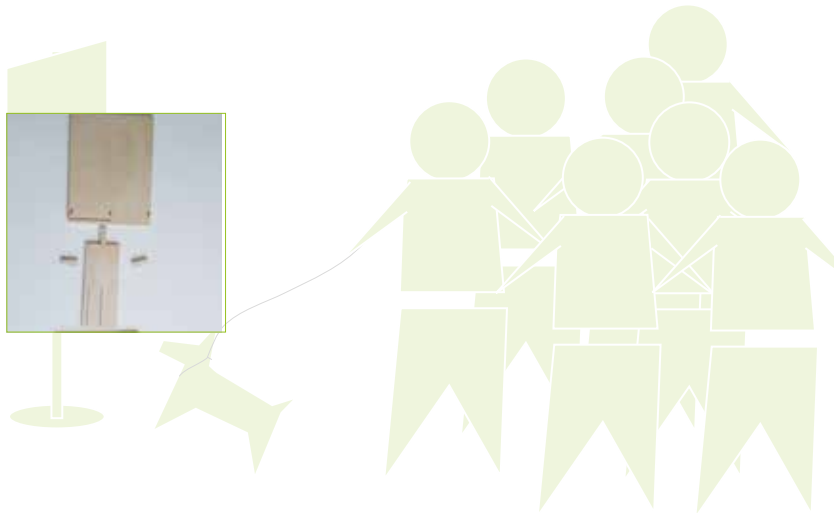

Item #	Item Description	Outer Box				
		PU	H (cm)	L (cm)	W (cm)	GW (kg)
02571	Wudi A4 / 2xDL, Birch Plywood					
02635	Wudi A5, Birch Plywood					
02636	Wudi DL, Birch Plywood					

*Coffee*  
**BREAK**

THE LOCAL UNIVERSITY  
Coffee



160

A CHANCE TO RELAX DURING FINALS WEEK  
AND TASTE SOME OF THE WORLD'S BEST COFFEE

**WEDNESDAY, DECEMBER 5**  
**2:00PM - 5:00PM**

Come meet fellow coffee lovers and take your mind off of  
studying to enjoy conversations and a relaxing hot beverage

*Admission \$10, includes 6 samples of fine coffee  
and a 16 oz cup of coffee to take with you.*

OPEN HOUSE STYLE AT THE STUDENT UNION BUILDING

ELEMENT BAMBOO

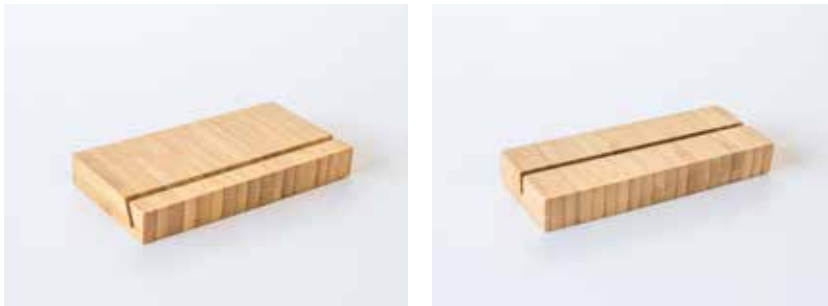

## Element Bamboo

- Base made of bamboo
- Branding via print or wood burning
- Compatible with our Universal Clip Sign
- Compatible with Element Silicone Strip

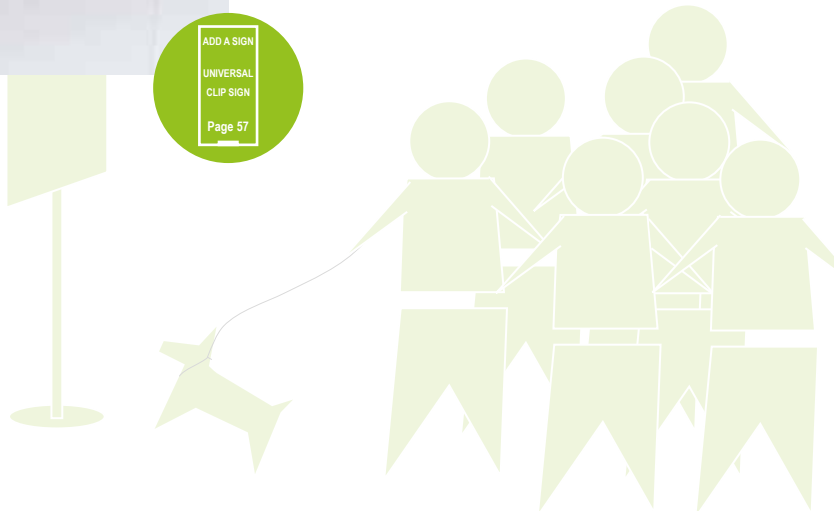
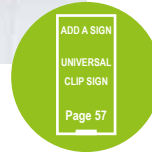

Item #	Item Description	PU	Outer Box			
			H (cm)	L (cm)	W (cm)	GW (kg)
02261	Element Bamboo Clip, 100, Angled	100 in 1 Box	23	45	26	9
02266	Element Bamboo Clip, 100, Straight	100 in 1 Box	26	35	23	9
02262	Element Bamboo Clip, 149, Angled	100 in 1 Box	32	45	26	15
02265	Element Bamboo Clip, 149, Straight	100 in 1 Box	26	35	32	11
02263	Element Bamboo Clip, 211, Angled	50 in 1 Box	23	45	26	11
02264	Element Bamboo Clip, 211, Straight	100 in 1 Box	26	35	23	9
02533	Element Bamboo Clip, 52, Angled	240 in 1 Box	26	48	32	15
02532	Element Bamboo Clip, 52, Straight	150 in 1 Box	26	35	20	8

## ELEMENT BEECH



Bestisch  
LEINE 1830  
2,71 - 3  
Platte Weißlaminat massiv mit Kante... gelack.  
€ 3.210,-

Bodenplatte und Beize Tisch Beize Antik  
Metallknoten € 629,-

87/79 106/140/75 cm € 4.139,-

Manzoni  
Handmade



# Tabletop and Counter Sign holders

## Element Beech



- Base made of beech wood
- Branding via print or wood burning
- Compatible with our Universal Clip Signs
- Compatible with Element Silicone Strip to enable usage with laminated cards

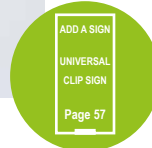

Item #	Item Description	PU	Outer Box			
			H (cm)	L (cm)	W (cm)	GW (kg)
02555	Element Beech Clip, 100, Angled, Oiled	100 in 1 Box	23	45	26	9
02556	Element Beech Clip, 100, Angled, Raw	100 in 1 Box	23	45	26	9
02557	Element Beech Clip, 100, Straight, Oiled	100 in 1 Box	26	35	23	9
02558	Element Beech Clip, 100, Straight, Raw	100 in 1 Box	26	35	23	9
02559	Element Beech Clip, 149, Angled, Oiled	100 in 1 Box	32	45	26	15
02560	Element Beech Clip, 149, Angled, Raw	100 in 1 Box	32	45	26	15
02561	Element Beech Clip, 149, Straight, Oiled	100 in 1 Box	26	35	32	11
02562	Element Beech Clip, 149, Straight, Raw	100 in 1 Box	26	35	32	11
02563	Element Beech Clip, 211, Angled, Oiled	50 in 1 Box	23	45	26	11
02564	Element Beech Clip, 211, Angled, Raw	50 in 1 Box	23	45	26	11
02565	Element Beech Clip, 211, Straight, Oiled	50 in 1 Box	23	35	26	9
02566	Element Beech Clip, 211, Straight, Raw	50 in 1 Box	23	35	26	9
02567	Element Beech Clip, 52, Angled, Oiled	150 in 1 Box	26	35	20	8
02568	Element Beech Clip, 52, Straight, Oiled	150 in 1 Box	26	35	20	8

Der Klassiker im neuen Look & Feel:  
Rolf Benz EGO.

Stoff-  
und Leder-  
Varianten



# Zahlreiche Varianten  
# Zeitloses Design  
# Made in Germany



**ROLF  
BENZ**

Hersteller ROLF BENZ AG, D-52134 Lutzerath, Tel. +49 (0)225 2400-0, Fax +49 (0)225 2400-100, E-Mail: info@rolfbenz.de, www.rolfbenz.de  
Produktionsstandort: D-52134 Lutzerath, Tel. +49 (0)225 2400-0, Fax +49 (0)225 2400-100, E-Mail: info@rolfbenz.de, www.rolfbenz.de

ELEMENT ALUMINIUM

## Element Aluminium



- Stable base, made of solid aluminium bar
- Branding via laser engraving
- Compatible with our Universal Clip Sign
- Compatible with Element Silicone Strip

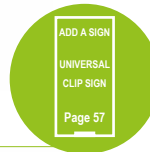

Item #	Item Description	PU	Outer Box			
			H (cm)	L (cm)	W (cm)	GW (kg)
02254	Element Alu Clip, 100, Angled	60 in 1 Bulk Box	17.50	30.50	25.00	15.40
02260	Element Alu Clip, 100, Straight	100 in 1 Bulk Box	17.00	35.00	25.00	14.80
02255	Element Alu Clip, 149, Angled	40 in 1 Bulk Box	22.50	30.50	18.50	15.10
02257	Element Alu Clip, 149, Straight	60 in 1 Bulk Box	20.00	35.00	18.00	13.20
02258	Element Alu Clip, 211, Angled	30 in 1 Bulk Box	17.00	30.50	25.00	16.10
02259	Element Alu Clip, 211, Straight	50 in 1 Bulk Box	17.00	35.00	25.00	15.50
02315	Element Alu Clip, 52, Angled	120 in 1 Bulk Box	20.00	30.50	15.00	15.60
02316	Element Alu Clip, 52, Straight	200 in 1 Bulk Box	15.00	35.00	31.00	15.00

## ELEMENT ACRYLIC



## Element Acrylic

- Stable base, 25mm thick clear acrylic
- Branding possible via silk screen printing
- Compatible with our Universal Clip Sign
- Compatible with Element Silicone Strip



Item #	Item Description	PU	Outer Box			
			H (cm)	L (cm)	W (cm)	GW (kg)
02220	Element Acrylic Clip, 100, Angled, Frost White	75 in 1 Bulk Box	18.00	40.00	35.00	13.00
02225	Element Acrylic Clip, 100, Straight, Frost White	100 in 1 Bulk Box	18.00	44.00	30.00	12.00
02221	Element Acrylic Clip, 149, Angled, Frost White	50 in 1 Bulk Box	18.00	40.00	33.00	13.00
02224	Element Acrylic Clip, 149, Straight, Frost White	75 in 1 Bulk Box	18.00	48.50	30.00	13.50
02222	Element Acrylic Clip, 211, Angled, Frost White	40 in 1 Bulk Box	18.00	45.50	32.00	14.50
02223	Element Acrylic Clip, 211, Straight, Frost White	50 in 1 Bulk Box	18.00	45.50	30.00	13.00

ELEMENT STONE





## Element Stone Clip Maxi Bright

- Natural stone
- Branding possible via pad print
- Compatible with our Universal Clip Sign
- Compatible with Element Silicone Strip



Item #	Item Description	PU	Outer Box			
			H (cm)	L (cm)	W (cm)	GW (kg)
02288	Element Stone Clip Maxi, Angled, Bright	30 in 1 Bulk Box	14.00	38.00	16.00	16.00
02289	Element Stone Clip Maxi, Straight, Bright	30 in 1 Bulk Box	14.00	38.00	16.00	16.00



## Element Stone Clip Midi Bright

- Natural stone
- Branding possible via pad print
- Compatible with our Universal Clip Sign
- Compatible with Element Silicone Strip



Item #	Item Description	PU	Outer Box			
			H (cm)	L (cm)	W (cm)	GW (kg)
02290	Element Stone Clip Midi, Angled, Bright	100 in 1 Bulk Box	17.00	23.00	20.00	13.50
02291	Element Stone Clip Midi, Straight, Bright	100 in 1 Bulk Box	17.00	23.00	20.00	13.50

# Tabletop and Counter Sign holders



## Element Stone Clip Maxi Dark

- Natural stone
- Branding possible via pad print
- Compatible with our Universal Clip Sign
- Compatible with Element Silicone Strip

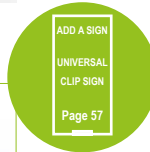

Item #	Item Description
02219	Element Stone Clip Maxi, Angled, Dark
02218	Element Stone Clip Maxi, Straight, Dark

PU	Outer Box			
	H (cm)	L (cm)	W (cm)	GW (kg)
30 in 1 Bulk Box	14.00	38.00	16.00	16.00
30 in 1 Bulk Box	14.00	38.00	16.00	16.00



## Element Stone Clip Midi Dark

- Natural stone
- Branding possible via pad print
- Compatible with our Universal Clip Sign
- Compatible with Element Silicone Strip

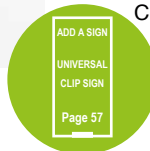

Item #	Item Description
02287	Element Stone Clip Midi, Angled, Dark
02286	Element Stone Clip Midi, Straight, Dark

PU	Outer Box			
	H (cm)	L (cm)	W (cm)	GW (kg)
100 in 1 Bulk Box	17.00	23.00	20.00	13.50
100 in 1 Bulk Box	17.00	23.00	23.00	13.50



# Tabletop and Counter Sign holders Accessories



## Uni Clip Signs

High-quality, versatile signs with an expandable bottom for a perfect fit. Compatible with our INSTAND system, Q EZI and ELEMENT lines.

- **Universal Use:** Suitable for various signage needs.
- **Perfect Fit:** Expandable bottom adapts to different stands.
- **Available Sizes:** From A7 landscape to A3.



Item #	Item Description	PU	Outer Box			
			H (cm)	L (cm)	W (cm)	GW (kg)
00909	Uni Clip Sign A3	20 in 1 Bulk Box	47	33	23	16.5
00910	Uni Clip Sign A3L	20 in 1 Box	44	45.5	35	20.5
00907	Uni Clip Sign A4	30 in 1 Bulk Box	34	34	24	15
00908	Uni Clip Sign A4L	30 in 1 Bulk Box	34	34	24	15
02114	Uni Clip Sign A5	50 in 1 Bulk Box	19	49	27	11
00906	Uni Clip Sign A5L	50 in 1 Bulk Box	19	55	25	11
02115	Uni Clip Sign A6	100 in 1 Bulk Box	37	22	25	10
02116	Uni Clip Sign A6L	100 in 1 Bulk Box	37	22	25	10
02335	Uni Clip Sign A7	100 in 1 Bulk Box	28	22	19	6
02333	Uni Clip Sign A7L	100 in 1 Bulk Box	28	22	19	6
02336	Uni Clip Sign A8	100 in 1 Bulk Box	27	22	25	6
02337	Uni Clip Sign A8L	100 in 1 Bulk Box	27	22	25	6
02123	Uni Clip Sign DL	100 in 1 Bulk Box	26	50	24	12.5



## Element Silicon Strip

- Enables thick paper and laminated cards to be inserted directly into any element tabletop and counter display
- Neutral color

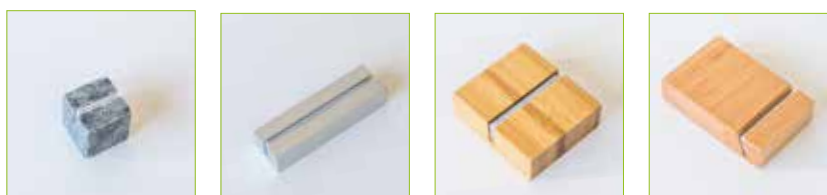

Item #	Item Description	PU	Outer Box			
			H (cm)	L (cm)	W (cm)	GW (kg)
02527	Element Silicone Strip 48, L-Gray	800 in 1 Bulk Box	15	30	30	3
02528	Element Silicone Strip 96, L-Gray	400 in 1 Bulk Box	15	30	30	3
02529	Element Silicone Strip, L-Gray, 100m/roll	1 in 1 Box	15	30	30	



INSPIN

# Tabletop and Counter Sign holders

## Inspin AD1



- Image pocket made of top quality clear acrylic, with finger hole for easy access
- Toploader! Image pocket sealed on sides and bottom
- 2 visual sides (front and back)
- Thick black acrylic base with ball bearing mechanism.
- Swivels very smoothly



Item #	Item Description
00044	InSpin AD1-A4
00110	InSpin AD1-A5
00518	InSpin AD1-A6
00045	InSpin AD1-DL

PU	Outer Box			
	H (cm)	L (cm)	W (cm)	GW (kg)
20 in 1 Box	39	77	70	20.6
50 in 1 Box	60	65	52	24.2
50 in 1 Box	50	55	43	14
50 in 1 Box	48	50	52	23

## Inspin AD3



- Image pockets made of top quality clear acrylic, with finger hole for easy access
- Toploader! Image pocket sealed on sides and bottom
- 6 visual sides
- Thick black acrylic base with ball bearing mechanism.
- Swivels very smoothly



Item #	Item Description
00043	InSpin AD3-A6
00519	InSpin AD3-A7
00080	InSpin AD3-DL

PU	Outer Box			
	H (cm)	L (cm)	W (cm)	GW (kg)
36 in 1 Box	56	76	41	21
50 in 1 Box	50	72	31	20
36 in 1 Box	56	76	53	24

# Tabletop and Counter Sign holders



## InSpin Triangle

- Image pockets made of top quality clear acrylic
- Image pockets sealed
- 3 visual sides
- Thick black acrylic base with ball bearing mechanism
- Swivels very smoothly
- Optionally stickers with table numbers can be supplied



Item #	Item Description	PU	Outer Box			GW (kg)
			H (cm)	L (cm)	W (cm)	
00502	InSpin Triangle DL	10 in 1 Box	31	72	30	7.5

## InSpin Basket

- Image pockets made of top quality clear acrylic
- Toploader! Image pockets sealed
- 2 visual sides
- Thick black acrylic base with ball bearing mechanism
- Swivels very smoothly
- With basket for coasters, salt and paper holder.



Item #	Item Description	PU	Outer Box			GW (kg)
			H (cm)	L (cm)	W (cm)	
01341	InSpin AD1-A5B Black	40 in 1 Box	61.00	73.00	71.00	24.00
02537	InSpin AD1-A5B White	40 in 1 Box	61.00	73.00	71.00	24.00
00151	InSpin AD1-DLB	40 in 1 Box	56.00	65.50	61.00	23.00
01340	InSpin AD1-DLB White	40 in 1 Box	56.00	65.50	61.00	23.00

# Tabletop and Counter Sign holders

## AD Basket



- Image pockets made of top quality clear acrylic
- Toploader! Image pockets sealed
- 2 visual sides
- With basket for coasters, salt and paper holder.



Item #	Item Description
01343	AD-DLB Black
01342	AD-DLB White

PU	Outer Box			
	H (cm)	L (cm)	W (cm)	GW (kg)
40 in 1 Box	59	63	58	15
40 in 1 Box	59	63	58	15

## Flip Basket



- Top quality acrylic
- Image pockets sealed
- 2 visual sides/pocket
- Including 6 pockets (can hold up to 12 pockets)
- With basket for coasters, salt and paper holder.



Item #	Item Description
02379	Flip DLB, Black
02380	Flip DLB, White

PU	Outer Box			
	H (cm)	L (cm)	W (cm)	GW (kg)
20 in 1 Box	43	69	68	13
20 in 1 Box	43	69	68	13

# Tabletop and Counter Sign holders



## Flip

- With secure metal clip rings, preventing sleeves from falling off.
- Base made of thick 10mm acrylic for solid support.
- Each unit includes 6 sleeves.

Item #	Item Description	PU	Outer Box			
			H (cm)	L (cm)	W (cm)	GW (kg)
02538	Flip A3	6 in 1 Box	35	75	54	18.5
02120	Flip A4	10 in 1 Bulk Box	26	54	44	13
02121	Flip A5	10 in 1 Bulk Box	19	45	34	7.5
02122	Flip DL	40 in 1 Bulk Box	28.5	61	36.5	21
02540	Pocket A3 for Flip, 6pcs/pack	10 in 1 Bulk Box	18	45	32	7.5
00831	Pocket A4 for Flip, 10pcs/pack	50 in 1 Bulk Box	37	32	23	18.5
00832	Pocket A5 for Flip, 10pcs/pack	50 in 1 Bulk Box	29	32	18	10.5
00833	Pocket DL for Flip, 10pcs/pack	100 in 1 Bulk Box	27	32	25	13.8
00931	Reverse Pliers for Flip	10 in 1 Box	15	25	20	4



## TMag

- Top quality clear acrylic with polished edges
- Top loader
- Base attaches with magnets, allowing the display of advertising print or table numbers.

Item #	Item Description	PU	Outer Box			
			H (cm)	L (cm)	W (cm)	GW (kg)
00695	T-Mag Sign Holder A4	20 in 1 Box	49.00	73.00	36.00	13.00
00694	T-Mag Sign Holder A5	50 in 1 Box	54.00	59.50	50.00	7.00
01432	T-Mag Sign Holder A6	50 in 1 Box	39.00	58.00	42.00	9.00
00693	T-Mag Sign Holder DL	50 in 1 Box	32.50	62.50	50.00	10.00
00713	T-Mag Triangle Sign Holder, DL white	10 in 1 Box	41.00	85.50	26.50	8.50

## Slim T-sign



- Top quality clear acrylic with polished edges

Item #	Item Description	PU	Outer Box			
			H (cm)	L (cm)	W (cm)	GW (kg)
01138	Slim T-sign holder A3	10 in 1 Box	32.00	68.00	45.00	11.50
01103	Slim T-sign holder A4	10 in 1 Box	23.00	51.00	32.00	5.00
01102	Slim T-sign holder A5	10 in 1 Box	17.00	50.00	23.00	3.00
01101	Slim T-sign holder DL	10 in 1 Box	12.00	50.00	23.00	2.50

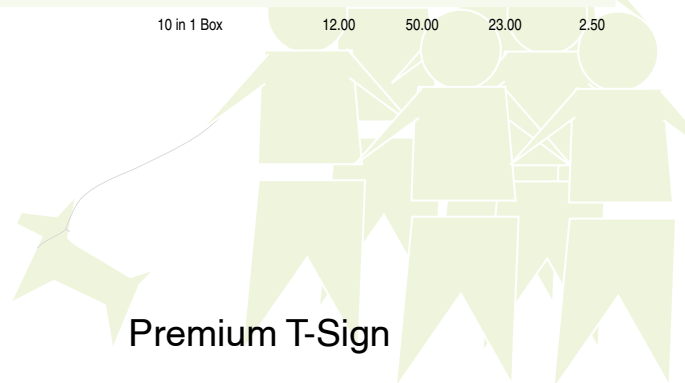

## Premium T-Sign



- Stable base, 6mm thick clear acrylic
- Top loading, sealed on 3 sides.
- With or without finger cut

Item #	Item Description	PU	Outer Box			
			H (cm)	L (cm)	W (cm)	GW (kg)
00996	Premium T-Sign holder 100 x 100	20 in 1 Bulk Box	14	59	17	3.5
01000	Premium T-Sign holder A3	10 in 1 Bulk Box	34	47	45	9.5
00999	Premium T-Sign holder A4	10 in 1 Bulk Box	26	37	33	6
00998	Premium T-Sign holder A5	10 in 1 Bulk Box	20	33	29	4.5
01097	Premium T-Sign holder A5L	20 in 1 Bulk Box	33	49	37	7
00936	Premium T-Sign holder A6	10 in 1 Bulk Box	16	33	22	3.5
00997	Premium T-Sign holder DL	10 in 1 Bulk Box	15	29	28	2
01098	Premium T-Sign holder DLL	20 in 1 bulk box	23	29	28	5





## Magnetic Notice Board Outdoor

Heavy Duty Outdoor Notice board

- Weather sealed
- Lockable
- With gas struts
- Tempered glass
- White board / magnetic steel back
- Very strong and robust anodized aluminum frame
- Portrait or landscape mount

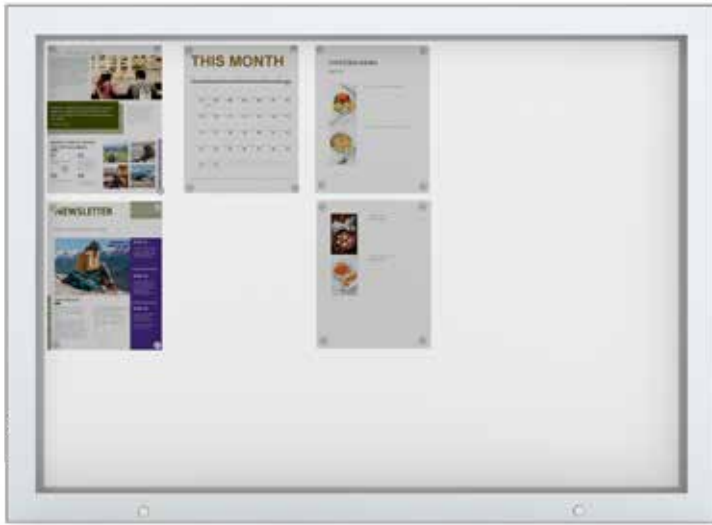

Item #	Item Description	PU	Outer Box			
			H (cm)	L (cm)	W (cm)	GW (kg)
00491	Notice Board Mag Outdoor 12 x A4	1 in 1 Box	9.00	106.00	103.00	27.50
00490	Notice Board Mag Outdoor 15 x A4	1 in 1 Box	9.00	125.00	106.50	34.00
00488	Notice Board Mag Outdoor 4 x A4	1 in 1 Box	9.00	77.00	60.50	10.50
00489	Notice Board Mag Outdoor 8 x A4	1 in 1 Box	9.00	102.00	77.00	20.00
02089	Notice Board Mag Outdoor A0	1 in 1 Box	9.00	135.00	102.00	34.00
02090	Notice Board Mag Outdoor A1	1 in 1 Box	9.00	125.00	77.00	20.00

## Fabric Notice Board Slim

- Fabric Notice board
- Weather sealed
  - Lockable
  - Felt back board
  - Polycarbonate door



Item #	Item Description	PU	Outer Box			GW (kg)
			H (cm)	L (cm)	W (cm)	
00496	Notice Board Slim Fabric 12 x A4	5 in 1 Box	108.00	111.00	31.00	68.00
00499	Notice Board Slim Fabric 4 x A4	5 in 1 Box	62.00	79.00	31.00	31.00
00498	Notice Board Slim Fabric 6 x A4	5 in 1 Box	61.00	111.00	31.00	45.00
00497	Notice Board Slim Fabric 9 x A4	5 in 1 Box	85.00	111.00	31.00	59.00

## Cork Notice Board Slim

- Cork Notice board
- Weather sealed
  - Lockable
  - Cork back board
  - Polycarbonate door



Item #	Item Description	PU	Outer Box			
			H (cm)	L (cm)	W (cm)	GW (kg)
00495	Notice Board Slim Cork 12 x A4	5 in 1 Box	108.00	111.00	31.00	68.00
00492	Notice Board Slim Cork 4 x A4	5 in 1 Box	62.00	79.00	31.00	31.00
00493	Notice Board Slim Cork 6 x A4	5 in 1 Box	61.00	111.00	31.00	45.00
00494	Notice Board Slim Cork 9 x A4	5 in 1 Box	85.00	111.00	31.00	58.00

## Magnetic Notice Board Slim

- Fix full posters with clips
- White board / magnetic steel back
- Lockable
- Polycarbonate door



Item #	Item Description	PU	Outer Box			
			H (cm)	L (cm)	W (cm)	GW (kg)
00067	Notice Board Slim PWM A0	2 in 1 Box	96.00	133.00	13.00	25.00
00068	Notice Board Slim PWM A1	5 in 1 Box	70.00	94.00	31.00	32.00
00051	Notice Board Slim PWM A2	5 in 1 Box	58.00	73.00	31.00	23.50
00069	Notice Board Slim PWM A3	5 in 1 Box	40.00	53.00	31.00	13.00
00070	Notice Board Slim PWM A4	5 in 1 Box	31.00	40.00	31.00	10.50
00486	Notice Board Slim PWM B1	5 in 1 Box	80.00	11.00	31.00	41.00
00487	Notice Board Slim PWM B2	5 in 1 Box	60.00	90.00	31.00	28.50

## Magnetic GlassBoard



Magnetic and writing glass board

- Magnetic back
- Round corners
- Landscape or portrait mount
- Including: 8 magnets, 1 magnetic pen holder and Whiteboard marker, wall standoff

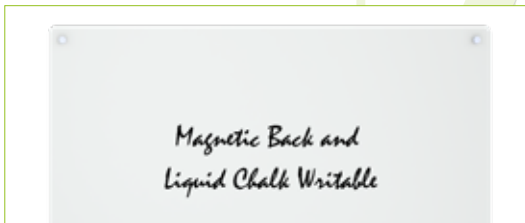

Item #	Item Description	PU	Outer Box			
			H (cm)	L (cm)	W (cm)	GW (kg)
00769	GlassBoard Magnetic 1200x900 black	1 in 1 Box	6.00	131.00	100.00	18.56
00770	GlassBoard Magnetic 1200x900 white	1 in 1 Box	6.00	131.00	100.00	18.56
02073	GlassBoard Magnetic 1800x1200 white	1 in 1 Box	6.00	190.00	130.00	35.56
02269	GlassBoard Magnetic 2100x1200 white	1 in 1 Box	6.00	221.00	130.00	38.00
02270	GlassBoard Magnetic 2400x1200 white	1 in 1 Box	6.00	251.00	130.00	44.00
01321	GlassBoard Magnetic 400x600 white	4 in 1 Box	25.00	69.00	49.00	15.50
01322	GlassBoard Magnetic 600x900 white	1 in 1 Box	6.00	100.00	70.00	8.50

**CLEAR FRAMES**



## Frameless Frame

- Top quality clear 3mm acrylic.
- With fingerhole on the front or back
- Sealed on 3 Sides
- Available with or without doublesided tape

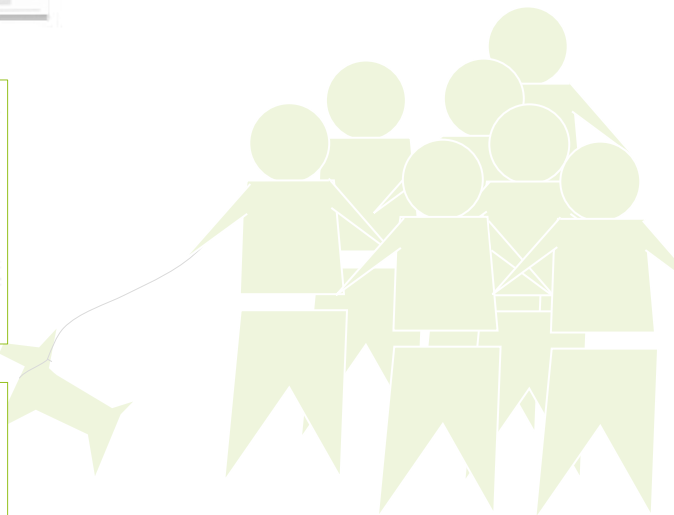
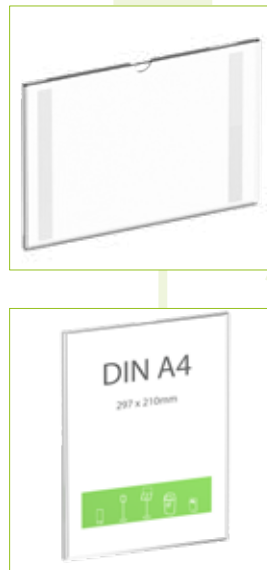

Item #	Item Description	PU	Outer Box			
			H (cm)	L (cm)	W (cm)	GW (kg)
00014	Frameless Frame A2	10 in 1 Box	33.00	62.00	46.00	22.60
02145	Frameless Frame A2, with Tape	10 in 1 Box	33.00	62.00	46.00	22.60
02119	Frameless Frame A2L	10 in 1 Box	33.00	62.00	46.00	22.60
02146	Frameless Frame A2L, with Tape	10 in 1 Box	33.00	62.00	46.00	22.60
00079	Frameless Frame A3	10 in 1 Bulk Box	34.00	45.00	15.00	11.00
02147	Frameless Frame A3, with Tape	10 in 1 Bulk Box	34.00	45.00	15.00	11.00
00948	Frameless Frame A3L	10 in 1 Bulk Box	34.00	45.00	15.00	11.00
02148	Frameless Frame A3L, with Tape	10 in 1 Bulk Box	34.00	45.00	15.00	11.00
00078	Frameless Frame A4	10 in 1 Bulk Box	34.00	25.00	15.00	6.50
02149	Frameless Frame A4, with Tape	10 in 1 Bulk Box	34.00	25.00	15.00	6.50
00949	Frameless Frame A4L	10 in 1 Bulk Box	34.00	25.00	15.00	6.50
02150	Frameless Frame A4L, with Tape	10 in 1 Bulk Box	34.00	25.00	15.00	6.50
02118	Frameless Frame A5	50 in 1 Bulk Box	31.00	48.00	19.00	14.00
02151	Frameless Frame A5, with Tape	50 in 1 Bulk Box	31.00	48.00	19.00	14.00
00827	Frameless Frame A5L	50 in 1 Bulk Box	31.00	48.00	19.00	14.00
02152	Frameless Frame A5L, with Tape	50 in 1 Bulk Box	31.00	48.00	19.00	14.00

## Glass Floating Frame



### Clear Glass Floating Frame

- 2 sheets of clear glass
- Round corners
- Landscape or portrait mount
- Including wall standoff



Item #	Item Description	PU	Outer Box			
			H (cm)	L (cm)	W (cm)	GW (kg)
01323	Glass Floating Frame A1 set clear, 2 layers	1 in 1 Box	6.00	103.50	79.00	14.00
01324	Glass Floating Frame A2 set clear, 2 layers	1 in 1 Box	6.00	78.50	61.00	7.80
02465	Glass Floating Frame A3 set clear, 2 layers	1 in 1 Box	6.00	61.00	49.00	4.30
02466	Glass Floating Frame A4 set clear, 2 layers	1 in 1 Box	6.00	49.00	40.00	2.30
02467	Glass Floating Frame A5 set clear, 2 layers	1 in 1 Box	6.00	40.00	34.00	1.30



## IMS pocket with Wall Side-Standoff



- Top quality clear 3mm acrylic IMS Pockets
- Compatible with IMS Wire Display
- Acrylic frame with corner magnets to keep the top closed
- Fold-over frames for easy image access
- Satin silver aluminum standoffs

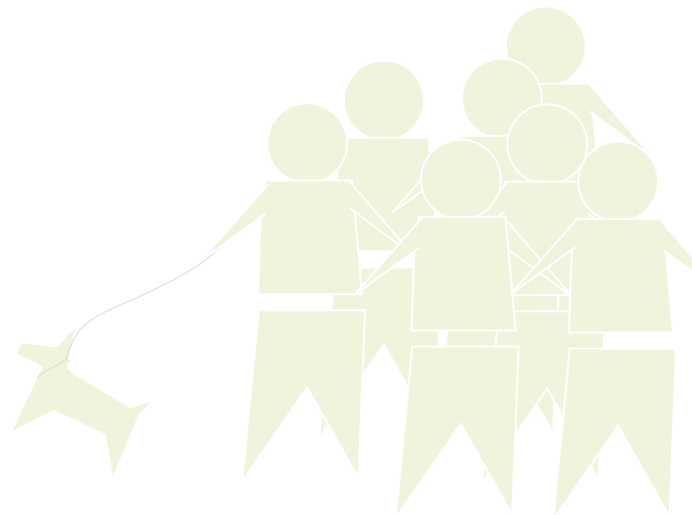

### IMS pockets

Item #	Item Description	PU	H (cm)	Outer Box		
				L (cm)	W (cm)	GW (kg)
01149	IMS pocket 30 x 40"	2 in 1 Bulk Box	13.00	112.50	90.00	19.00
01264	IMS pocket A0	4 in 1 Box	13.00	129.50	98.00	32.50
01118	IMS pocket A0L	4 in 1 Box	13.00	129.50	98.00	32.50
00016	IMS pocket A1	5 in 1 Box	19.00	95.00	73.00	30.00
00021	IMS pocket A1L	5 in 1 Box	17.00	95.00	68.50	23.00
00017	IMS pocket A2	10 in 1 Box	38.00	64.00	48.50	23.00
00022	IMS pocket A2L	10 in 1 Box	34.00	66.00	46.00	22.20
00018	IMS pocket A3	20 in 1 Box	37.00	66.00	47.00	24.50
00023	IMS pocket A3L	20 in 1 Box	48.50	64.00	34.00	23.80
00019	IMS pocket A4	40 in 1 Box	54.00	67.00	35.00	25.60
00024	IMS pocket A4L	40 in 1 Box	36.50	64.00	48.00	25.00
00020	IMS pocket B1	4 in 1 Box	13.00	112.00	80.00	22.30

### Side-Standoff

Item #	Item Description	PU	H (cm)	Outer Box		
				L (cm)	W (cm)	GW (kg)
00171	IMS Wall Side-Standoff Midi, set of 4pcs	125 in 1 Bulk Box	22.00	32.00	22.00	12.00
01270	IMS Wall Side-Standoff Mini, set of 4pcs	125 in 1 Bulk Box	22.00	32.00	22.00	9.00

## Wall Clip Sign

Sign holder, ideal for door or direction signs.

- White powder coated aluminum for discreet look
- For acrylic, glass or wood signs up to 5mm thick
- Compatible with our Uni Clip Signs

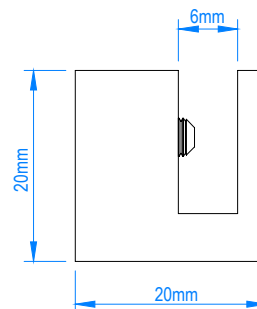
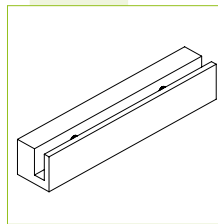
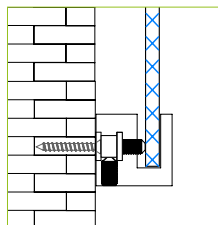
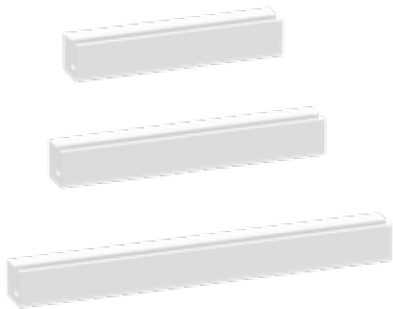

Item #	Item Description	PU	Outer Box			
			H (cm)	L (cm)	W (cm)	GW (kg)
02213	Wall Clip 106, White matt	144 in 1 Bulk Box	21.00	46.00	17.00	13.50
02211	Wall Clip 149, White matt	108 in 1 Bulk Box	17.00	48.00	21.00	14.50
02212	Wall Clip 211, White matt	72 in 1 Bulk Box	21.00	45.00	17.00	13.50
02267	Uni Clip Sign 100 x 100	100 in 1 Bulk Box	15.00	50.00	24.00	7.00
00907	Uni Clip Sign A4	30 in 1 Bulk Box	34.00	34.00	24.00	15.00
02114	Uni Clip Sign A5	50 in 1 Bulk Box	19.00	55.00	25.00	11.00
00906	Uni Clip Sign A5L	50 in 1 Bulk Box	19.00	55.00	25.00	11.00
02115	Uni Clip Sign A6	100 in 1 Bulk Box	37.00	22.00	25.00	10.00

### Wall Flag Sign Clip



Wall flag sign clip, Ideal for hallway directions.

- White powder coated aluminum for discreet look
- For acrylic, glass or wood signs up to 5mm thick
- Compatible with our Uni Clip Signs (Page 81)

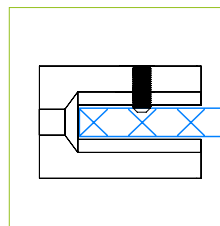
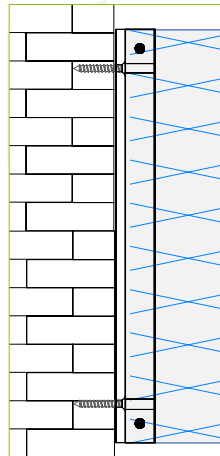

14mm

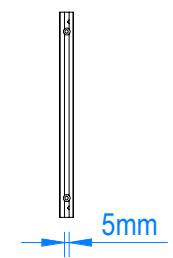

211 / 149 / 106 mm

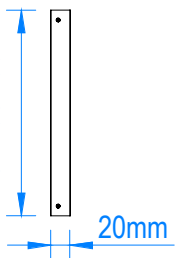

Item #	Item Description	PU	H (cm)	Outer Box		
				L (cm)	W (cm)	GW (kg)
02534	Wall Flag Sign Clip 106, White matt	100 in 1 Bulk Box	12	30	26	7
02535	Wall Flag Sign Clip 149, White matt	100 in 1 Bulk Box	12	30	34	10
02536	Wall Flag Sign Clip 211, White matt	100 in 1 Bulk Box	22	30	25	13.5

# Wall Frames & Sign Holders Fixtures



## IMS Mirror Mount

- Brass with Brushed Stainless Cap
- Flat top
- Requires panel hole 6mm

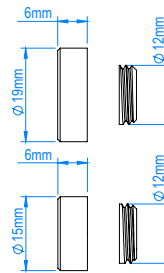
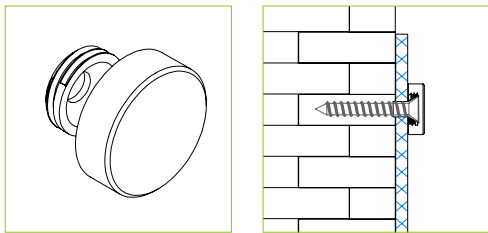

Item #	Item Description	Outer Box				
		PU	H (cm)	L (cm)	W (cm)	GW (kg)
02236	IMS Mirror Mount ss Midi, set of 4pcs	200 in 1 Bulk Box	22.00	32.00	22.00	11.00
02237	IMS Mirror Mount ss Mini, set of 4pcs	200 in 1 Bulk Box	22.00	32.00	22.00	8.00



## IMS Wall Standoff

- Brushed Stainless Steel
- Flat top

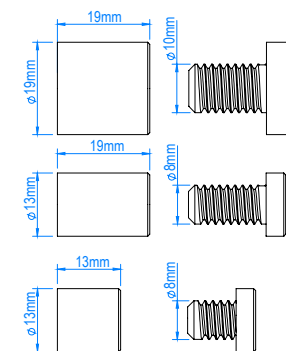
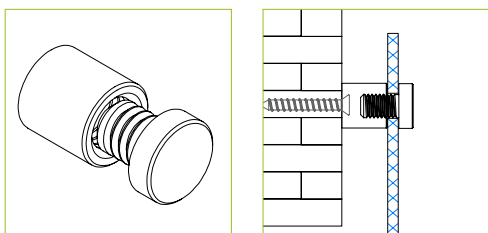

Item #	Item Description	Outer Box				
		PU	H (cm)	L (cm)	W (cm)	GW (kg)
02235	IMS Wall Standoff ss Maxi, set of 4pcs (Maximum Panel Thickness 10mm)	100 in 1 Bulk Box	16.00	32.00	22.00	24.00
02234	IMS Wall Standoff ss Midi, set of 4pcs (Maximum Panel Thickness 10mm)	100 in 1 Bulk Box	16.00	32.00	22.00	13.00
02233	IMS Wall Standoff ss Mini, set of 4pcs (Maximum Panel Thickness 5mm)	200 in 1 Bulk Box	22.00	32.00	22.00	15.50



## IMS Wall Side-Standoff

- Satin silver aluminum standoffs
- Flat front
- Maximum panel thickness 4mm

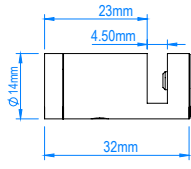
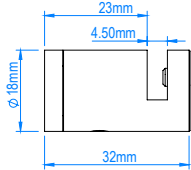
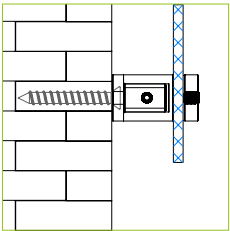
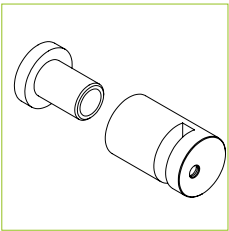

Item #	Item Description
00171	IMS Wall Side-Standoff Midi, set of 4pcs
01270	IMS Wall Side-Standoff Mini, set of 4pcs

PU	Outer Box			
	H (cm)	L (cm)	W (cm)	GW (kg)
125 in 1 Bulk Box	22.00	32.00	22.00	12.00
125 in 1 Bulk Box	22.00	32.00	22.00	9.00



## IMS Wall 4-Way-Standoff

- Satin silver aluminum standoffs
- Flat front
- Panel thickness 3-12mm

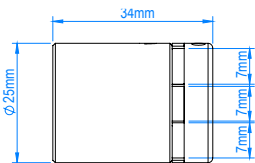
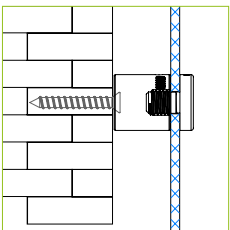
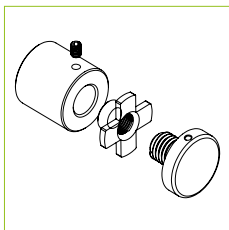

Item #	Item Description
02302	IMS Wall 4-Way-Standoff 2.5, set of 4pcs

PU	Outer Box			
	H (cm)	L (cm)	W (cm)	GW (kg)
50 in 1 Bulk Box	16.00	32.00	22.00	9.50



IMS SIGN DISPLAY



## IMS pockets

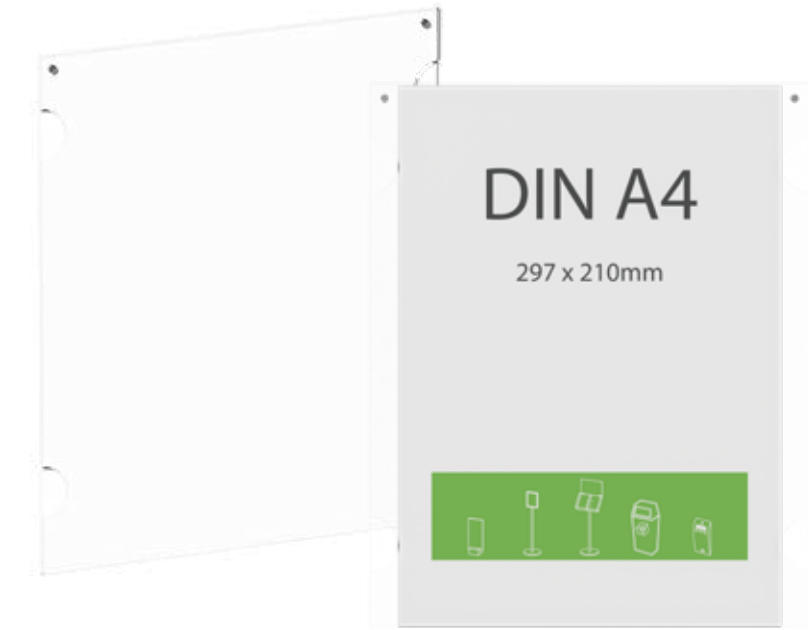

### IMS Acrylic pockets

- Top quality clear 3mm acrylic pocket.
- Acrylic frame with corner magnets that are to keep the top closed
- Fold-over frames for easy image access
- Compatible with IMS Brochure Holders

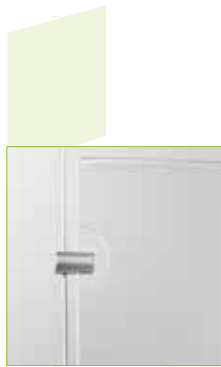

Item #	Item Description	PU	H (cm)	Outer Box		
				L (cm)	W (cm)	GW (kg)
01149	IMS pocket 30 x 40"	2 in 1 Bulk Box	13.00	112.50	90.00	19.00
01264	IMS pocket A0	4 in 1 Box	13.00	129.50	98.00	32.50
01118	IMS pocket A0L	4 in 1 Box	13.00	129.50	98.00	32.50
00016	IMS pocket A1	5 in 1 Box	19.00	95.00	73.00	30.00
00021	IMS pocket A1L	5 in 1 Box	17.00	95.00	68.50	23.00
00017	IMS pocket A2	10 in 1 Box	38.00	64.00	48.50	23.00
00022	IMS pocket A2L	10 in 1 Box	34.00	66.00	46.00	22.20
00018	IMS pocket A3	20 in 1 Box	37.00	66.00	47.00	24.50
00023	IMS pocket A3L	20 in 1 Box	48.50	64.00	34.00	23.80
00019	IMS pocket A4	40 in 1 Box	54.00	67.00	35.00	25.60
00024	IMS pocket A4L	40 in 1 Box	36.50	64.00	48.00	25.00
00020	IMS pocket B1	4 in 1 Box	13.00	112.00	80.00	22.30



**IMS**

BROCHURE DISPLAY



## IMS Brochure Holder

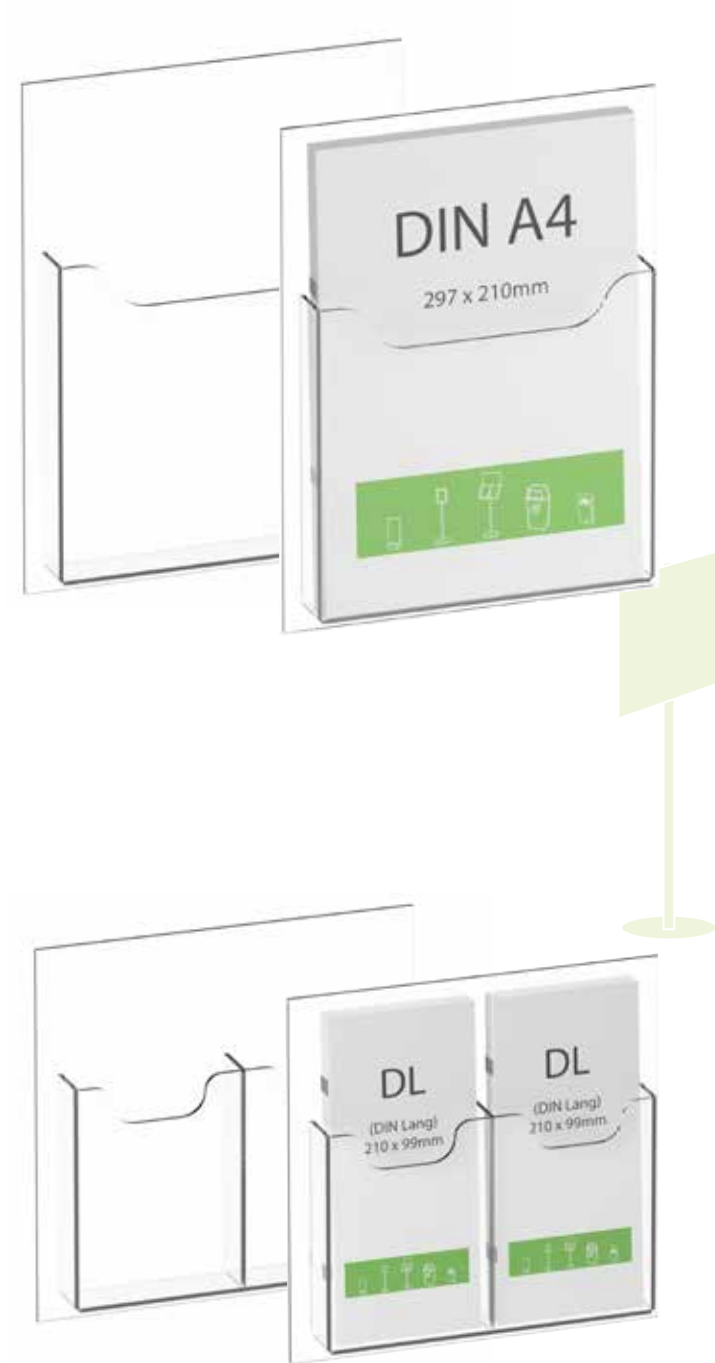

- Top quality clear 3mm acrylic pocket.
- 3cm depth for brochures.
- Width matches A4 IMS pockets, enabling combinations of posters and brochures in the same column.

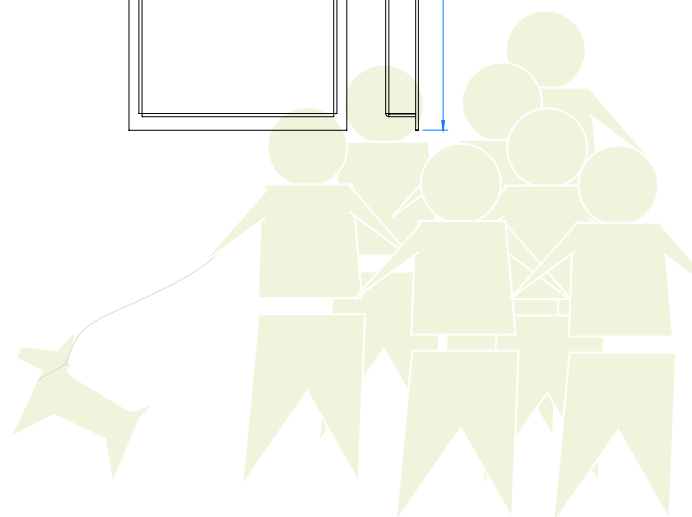
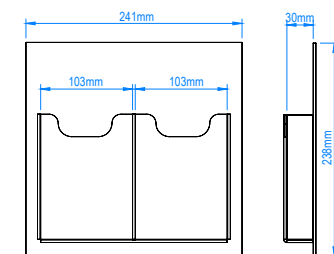
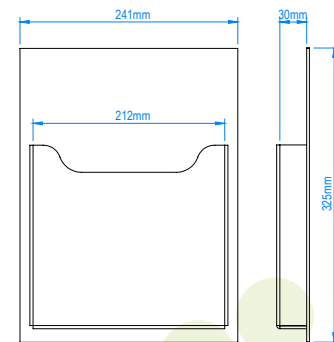

Item #	Item Description	PU	H (cm)	Outer Box		
				L (cm)	W (cm)	GW (kg)
02232	IMS Brochure Holder 2 x DL	5 in 1 Bulk Box	26.50	27.00	24.00	19.00
02137	IMS Brochure Holder A4	5 in 1 Bulk Box	35.50	40.00	27.00	32.50

# Hanging Frames & Sign Holders

## Fixtures



### IMS Ceiling/Floor Fitting

- Satin silver aluminum
- 4m long cable
- 15kg load per column

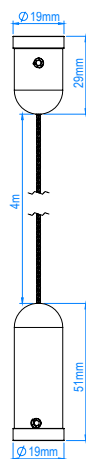

Item #	Item Description	Outer Box				
		PU	H (cm)	L (cm)	W (cm)	GW (kg)
00166	IMS Ceiling Floor Fitting	100 in 1 Bulk Box	22.00	32.00	22.00	12.00

### IMS Wall Conversion Kit

- Satin silver aluminum
- For mounting Ceiling Floor Fitting to the Wall

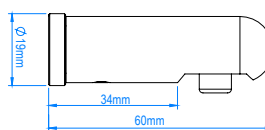
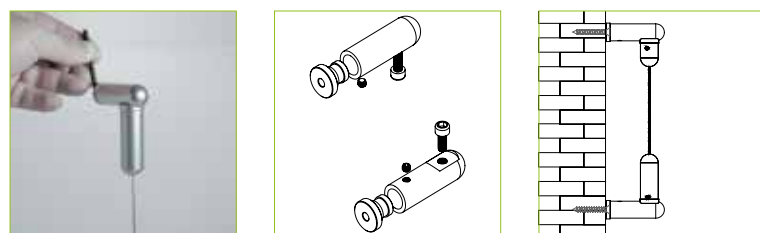

Item #	Item Description	Outer Box				
		PU	H (cm)	L (cm)	W (cm)	GW (kg)
01040	IMS Wall Conversion Kit set of 2pcs	150 in 1 Bulk Box	22.00	32.00	22.00	12.00
00170	IMS Wall Conversion Kit set of 4pcs	75 in 1 Bulk Box	22.00	32.00	22.00	9.00



### IMS Single Site Clamp

- 4 pcs in a set
- Satin silver aluminum
- Small size

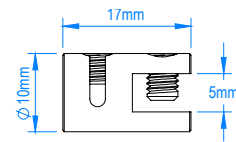
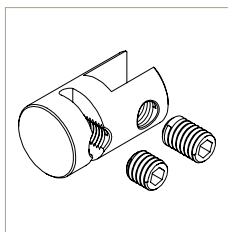

Item #	Item Description	PU	Outer Box			GW (kg)
			H (cm)	L (cm)	W (cm)	
00315	IMS Single Site Clamp set of 4	500 in 1 Bulk Box	22.00	32.00	22.00	6.50



### IMS Double Site Clamp

- 4 pcs in a set
- Satin silver aluminum
- Small size

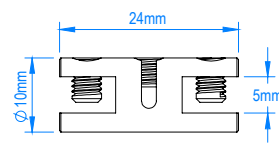
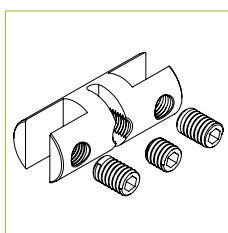

Item #	Item Description	PU	Outer Box			GW (kg)
			H (cm)	L (cm)	W (cm)	
00169	IMS Double Site Clamp set of 4pcs	250 in 1 Bulk Box	16.00	32.00	22.00	4.00

# Hanging Frames & Sign Holders

## Fixtures



### IMS Ceiling Hanging Fitting

- Aluminum, satin silver
- 4m long cable
- Maximum panel thickness: 8mm
- Maximum weight 10kg

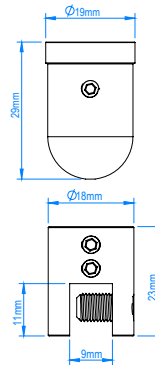
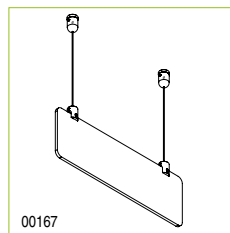
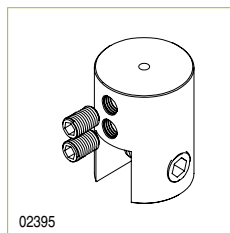
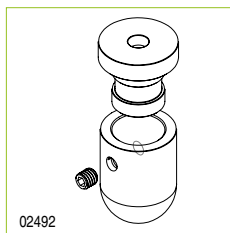

Item #	Item Description	Outer Box				
		PU	H (cm)	L (cm)	W (cm)	GW (kg)
02395	IMS Ceiling Hanging Clamp set of 2	180 in 1 Bulk Box	22.00	32.00	22.00	7.00
00167	IMS Ceiling Hanging Fitting set of 2kits	120 in 1 Bulk Box	22.00	32.00	22.00	10.00
02492	IMS Top Ceiling attachment set of 2	180 in 1 Bulk Box	22.00	32.00	22.00	6.50



### IMS Self Gripping Ceiling Fastener

- Brass, polished chrome
- Fits 1.5mm cables
- Single unit holds 10kg load

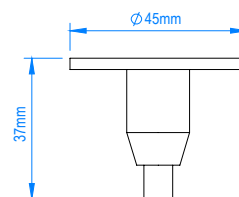
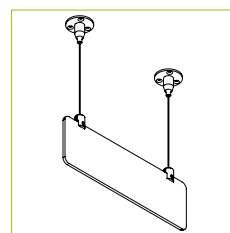
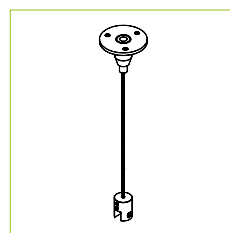
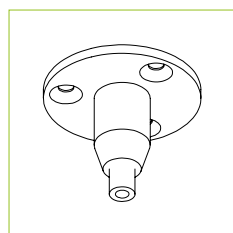

Item #	Item Description	Outer Box				
		PU	H (cm)	L (cm)	W (cm)	GW (kg)
00305	IMS Self Gripping Ceiling Fastener	180 in 1 Bulk Box	22.00	32.00	22.00	13.50

### IMS Self Gripping Hook

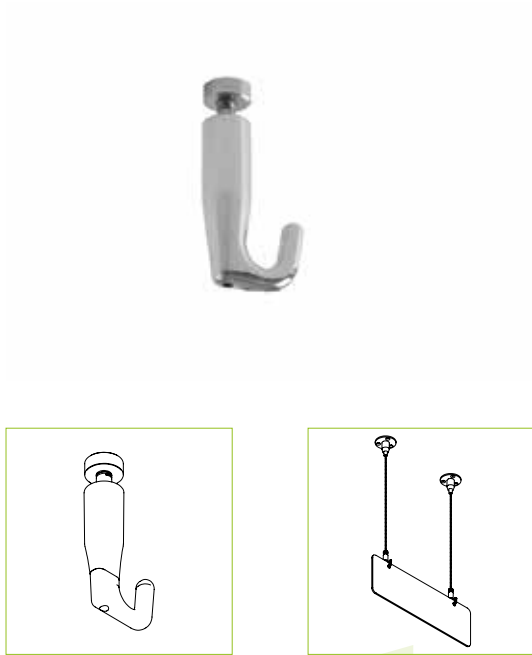

- Brass, polished chrome
- Fits 1.5mm cables
- Single unit holds 10kg load

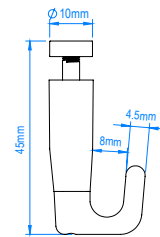

00305 + 00011 + 01417

Item #	Item Description	PU	Outer Box			
			H (cm)	L (cm)	W (cm)	GW (kg)
01417	IMS Self Gripping Hook	300 in 1 Bulk Box	22.00	32.00	22.00	8.00



### IMS Cable

- Chrome
- 4m long cable
- 1.5mm thick
- With stopper on one end

Item #	Item Description	PU	Outer Box			
			H (cm)	L (cm)	W (cm)	GW (kg)
00011	IMS Cable 1,5mm x 4m	250 in 1 Bulk Box	22.00	32.00	22.00	8.50

fepro  
facility

p 89 - 95

p 96 - 107

p 108 - 111

p 112 - 115

p 116 - 119

- Waste Receptacles
- Cigarette Receptacles
- Canine Dispensers / Dog Poop Bags
- Crowd Control
- Dispensers

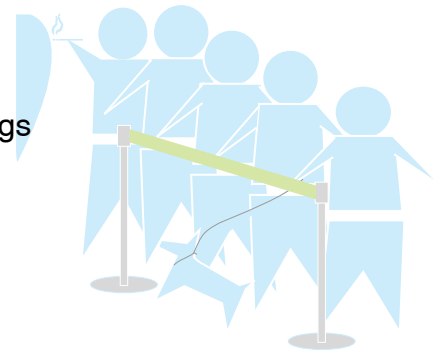

## Commercial Waste Receptacles





## Kubel

No Touch Disposal



- Available in black and stainless
- All metal body reduces risk of fire e.g. in hotel rooms or offices with carpets or wood floor.
- 3 Sizes - Same design for different areas with different traffic.
- No touch disposal: waste drop on top without touching
- No sharp edges
- Optional with rubber rim on bottom

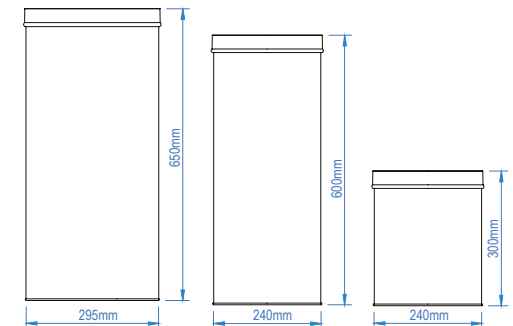
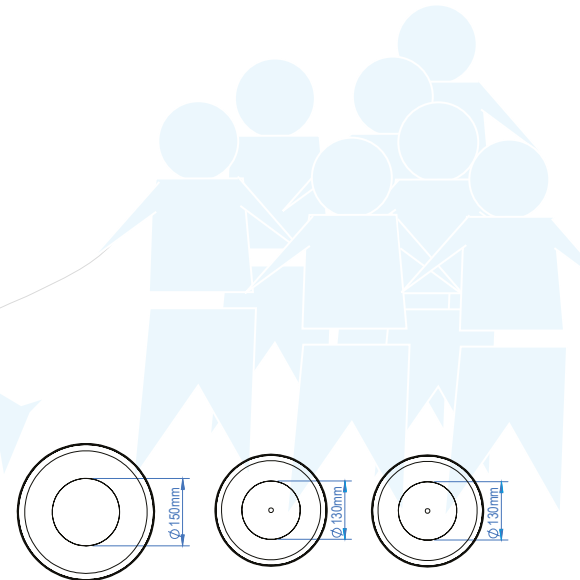

Item #	Item Description	PU	Outer Box			GW (kg)
			H (cm)	L (cm)	W (cm)	
02391	KUBEL Maxi Black	1 in 1 Box	67	32	32	7
02390	KUBEL Maxi Stainless	1 in 1 Box	67	32	32	6
02392	KUBEL Midi Black	1 in 1 Box	62	27	27	4
02389	KUBEL Midi Stainless	1 in 1 Box	62	27	27	5
02387	KUBEL Mini Black	6 in 1 Box	32	78	53	11
02388	KUBEL Mini Stainless	6 in 1 Box	32	78	53	11

# Waste Receptacles

No Touch Disposal

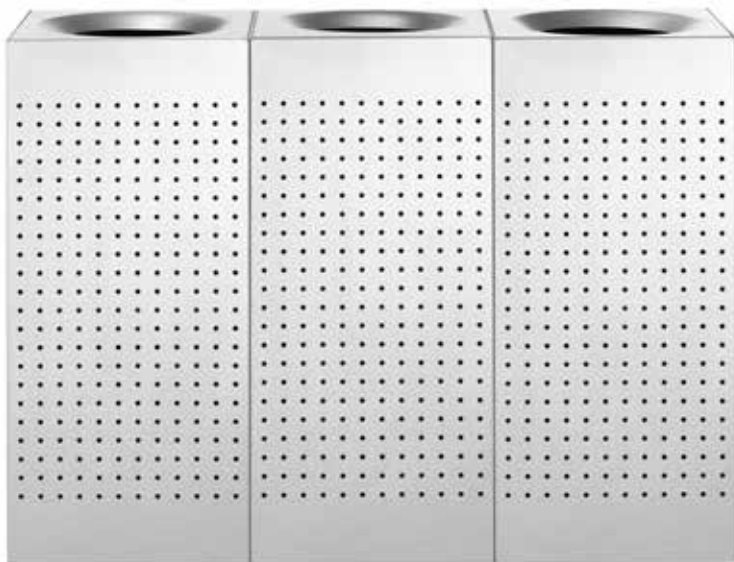

## KUBICK

- Available in stainless or powder coated
- Retainer bands hold trash liner in place
- No touch disposal: waste drop on top without touching
- Ideal for any recycling program - link as many Kubick bins as required.
- Recycling decals can be provided and added upon request.
- Also available with galvanized liner

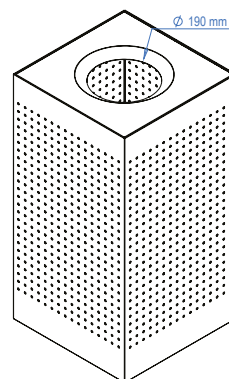
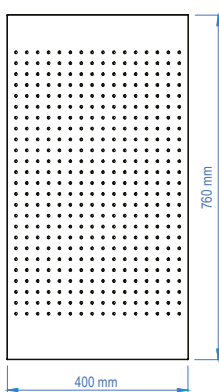
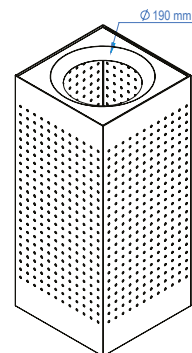
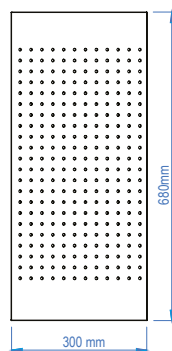

Item #	Item Description	PU	Outer Box			
			H (cm)	L (cm)	W (cm)	GW (kg)
02153	KUBICK Maxi Dark Gray	1 in 1 Box	79	43	43	15
01121	KUBICK Maxi RAL 7043	1 in 1 Box	79	43	43	13
01122	KUBICK Maxi Stainless	1 in 1 box	79	43	43	13.2
02154	KUBICK Midi Dark Gray	1 in 1 Box	71	32	32	10
01120	KUBICK Midi RAL 7043	1 in 1 Box	71	32	32	8.2
01119	KUBICK Midi Stainless	1 in 1 Box	71	32	32	7.5

No Touch Disposal



## DOM

- Available in black or black with stainless top
- All metal body and liner - reduces risk of fire in areas with carpets or wood floor.
- Large liner for high traffic.
- No touch disposal: waste drop on top without touching
- Clean look: dome top hides waste even when liner is full
- No sharp edges
- Optional with rubber rim on bottom

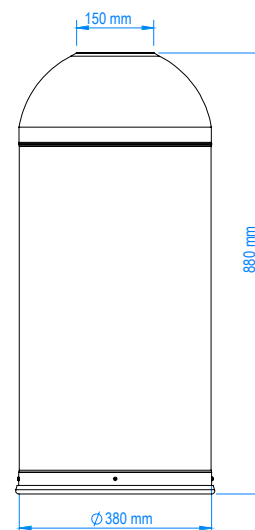

Item #	Item Description	PU	Outer Box			GW (kg)
			H (cm)	L (cm)	W (cm)	
00687	DOM Black	1 in 1 Box	100	41	41.5	9.58
00688	DOM PC/SS Black/Stainless top	1 in 1 Box	100	41	41.5	9.58

# Waste Receptacles

No Touch Disposal



## Korb

- Double walled, hiding the bag completely
- Stainless steel or black
- No touch disposal: waste drop on top without touching
- All metal body reduces risk of fire in areas with carpets or wood floor.

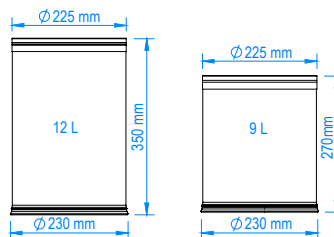

Item #	Item Description	PU	Outer Box			GW (kg)
			H (cm)	L (cm)	W (cm)	
00809	KORB 12L Black	1 in 1 Box	37	24	24	2.5
00810	KORB 12L Stainless	1 in 1 Box	37	24	24	2.5
02393	KORB 9L Black	6 in 1 Box	28.5	72.5	48.5	10
02394	KORB 9L Stainless	6 in 1 Box	28.5	72.5	48.5	11



## Sieb

- Optimal as simple dust bin or umbrella stand
- Full metal body, powder coated
- Optional with plastic tray

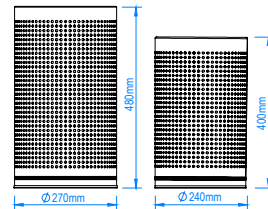

Item #	Item Description	PU	H (cm)	Outer Box		
				L (cm)	W (cm)	GW (kg)
02292	Sieb Midi Perforated Bin, Black	4 in 1 Box	50	52	52	10.5
02295	Sieb Midi Perforated Bin, dark Gray	4 in 1 Box	50	52	52	10.5
02294	Sieb Midi Perforated Bin, White	4 in 1 Box	50	52	52	10.5
02297	Sieb Mini Perforated Bin, Black	4 in 1 Box	43	52	52	9
02296	Sieb Mini Perforated Bin, dark Gray	4 in 1 Box	43	52	52	9
02298	Sieb Mini Perforated Bin, White	4 in 1 Box	43	52	52	9

## Battery Tube

- Battery look
- For wall or pole mount
- Full metal body powder coated
- With removable internal liner

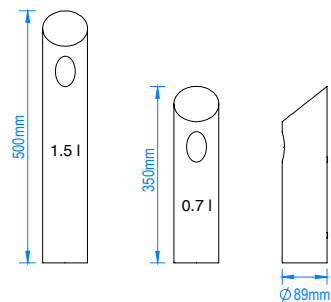

Item #	Item Description	PU	H (cm)	Outer Box		
				L (cm)	W (cm)	GW (kg)
00642	Battery Tube Midi, PC	4 in 1 Box	55	30.5	22.8	10.5
00641	Battery Tube Mini, PC	4 in 1 Box	40	30.5	22.8	10.5

**Urban  
Waste Solutions**





## Cyli

- Outdoor bin for litter bags
- Retainer bands hold trash liner in place
- Made of galvanized steel with powder coating
- Perforated body enables good ventilation

Item #	Item Description	PU	Outer Box			GW (kg)
			H (cm)	L (cm)	W (cm)	
02423	Cyli Maxi Perforated Bin, Black	1 in 1 Box	62	37	33	6.5
00683	Cyli Maxi Perforated Bin, dark Gray	1 in 1 Box	62	37	33	6.5
00682	Cyli Maxi Perforated Bin, Green	1 in 1 Box	62	37	33	6.5
01312	Cyli Maxi Perforated Bin, RAL 7043	1 in 1 Box	62	37	33	6.5



## Urbin

- A classic Urban litter bin.
- For use without or with litter bags
- Robust and functional construction
- Fixtures enable fixing on any post or pole

Item #	Item Description	PU	Outer Box			GW (kg)
			H (cm)	L (cm)	W (cm)	
02641	Urbin Green	1 in 1 Box	70	45	34	4.1
02640	Urbin Orange	1 in 1 Box	70	45	34	4.1
02642	Urbin Silver	1 in 1 Box	70	45	34	4.1



## Smokers' Waste Solutions

Fepro offers a diverse range of commercial-grade cigarette disposal solutions, designed for durability and safety with removable internal containers and oxygen-suffocating covers, available in various sizes and styles for both wall-mounted and freestanding options.



## Curved



- For outdoor use: complete body made of stainless steel or galvanized steel with powder coating
- Easy maintenance: removable internal container
- Reduces smoke emission and danger of fire: Max & Midi Internal container equipped with an oxygen-suffocating-cover
- Holes for cigarette waste are made to fit cigarettes only - preventing misuse as trash bin
- Wall or pole mount
- Lockable

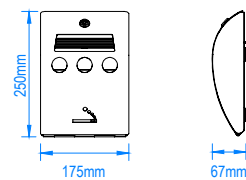
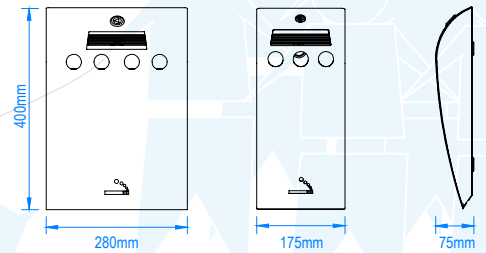

Item #	Item Description	PU	Outer Box			
			H (cm)	L (cm)	W (cm)	GW (kg)
01389	Curved Maxi Black	4 in 1 Box	45	36	31	15.6
00456	Curved Maxi dark Gray	4 in 1 Box	45	36	31	15.6
01305	Curved Maxi RAL 7043	4 in 1 Box	45	36	31	15.6
00128	Curved Maxi Stainless	4 in 1 Box	45	35	31	16.6
01388	Curved Midi Black	4 in 1 Box	20	36	45	7.2
01082	Curved Midi dark Gray	4 in 1 Box	20	36	45	7.2
01251	Curved Midi RAL 7043	4 in 1 Box	20	36	45	7.2
01083	Curved Midi Stainless	4 in 1 Box	20	36	45	7.2
01387	Curved Mini Black	8 in 1 Box	30	39	32	11.7
01081	Curved Mini dark Gray	8 in 1 Box	30	39	32	11.7
01250	Curved Mini RAL 7043	8 in 1 Box	30	39	32	11.7
01080	Curved Mini Stainless	8 in 1 Box	30	39	32	13.9

# Cigarette Receptacles



## AD Line

- With advertising window in A4 size. Advertising panel is made of clear acrylic in heavy 3 mm quality.
- Images can be insert and changed easily, the acrylic window can be removed, opened and cleaned.
- Lockable restricting access to advertising panel. Internal liner has a oxygen-suffocating-cover to reduce smoke and fire danger.
- For outdoor use: made of stainless steel or galvanized steel with powder coating
- Holes for cigarette waste are made to fit cigarettes only - preventing misuse as trash bin.
- Easy maintenance: removable internal container.
- For wall or pole mount

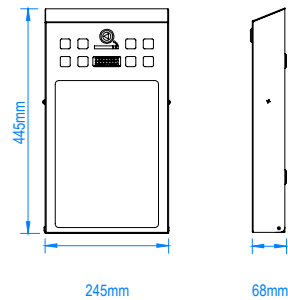
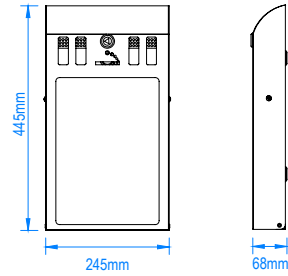

Item #	Item Description	Outer Box				
		PU	H (cm)	L (cm)	W (cm)	GW (kg)
00165	AD Line Curved Dark Gray	4 in 1 Box	51	34	28	18.6
00446	AD Line Curved Stainless	4 in 1 Box	51	34	28	14.3
00444	AD Line Dark Gray	4 in 1 Box	51	34	28	18.6
00130	AD Line Stainless	4 in 1 Box	51	34	28	14.3

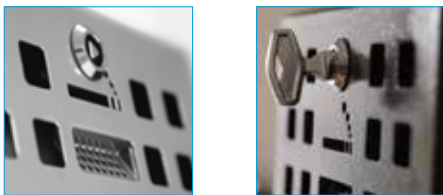

## Slim Line

- For outdoor use: made of stainless steel or galvanized steel with powder coating.
- Safe and secure! Lockable. Internal liner has a oxygen-suffocating-cover to reduce smoke and fire danger.
- Holes for cigarette waste are made to fit cigarettes only - preventing misuse as trash bin.
- Easy maintenance: removable internal container.
- For wall or pole mount

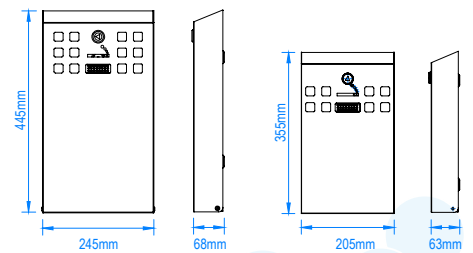

Item #	Item Description	PU	Outer Box			
			H (cm)	L (cm)	W (cm)	GW (kg)
00163	Slim Line Maxi Black	4 in 1 Box	50	33.5	28	19.5
00454	Slim Line Maxi Dark Gray	4 in 1 Box	50	33.5	28	19.5
00447	Slim Line Maxi Stainless	4 in 1 Box	50	33.5	28	19.5
00162	Slim Line Midi Black	4 in 1 Box	41	32	24	11
00455	Slim Line Midi Dark Gray	4 in 1 Box	41	32	24	11
00448	Slim Line Midi Stainless	4 in 1 Box	41	32	24	11



## Curved Classic

- Easy maintenance: removable internal container. Stainless Steel front is easy to wipe.
- Lockable. Internal liner has a oxygen-suffocating-cover to reduce smoke and fire danger.
- Holes for cigarette waste are made to fit cigarettes only - preventing misuse as trash bin.
- For wall or pole mount

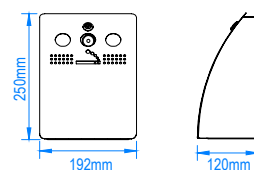

Item #	Item Description	PU	Outer Box			
			H (cm)	L (cm)	W (cm)	GW (kg)
00194	Curved Classic	4 in 1 Box	32	44	29	9.2

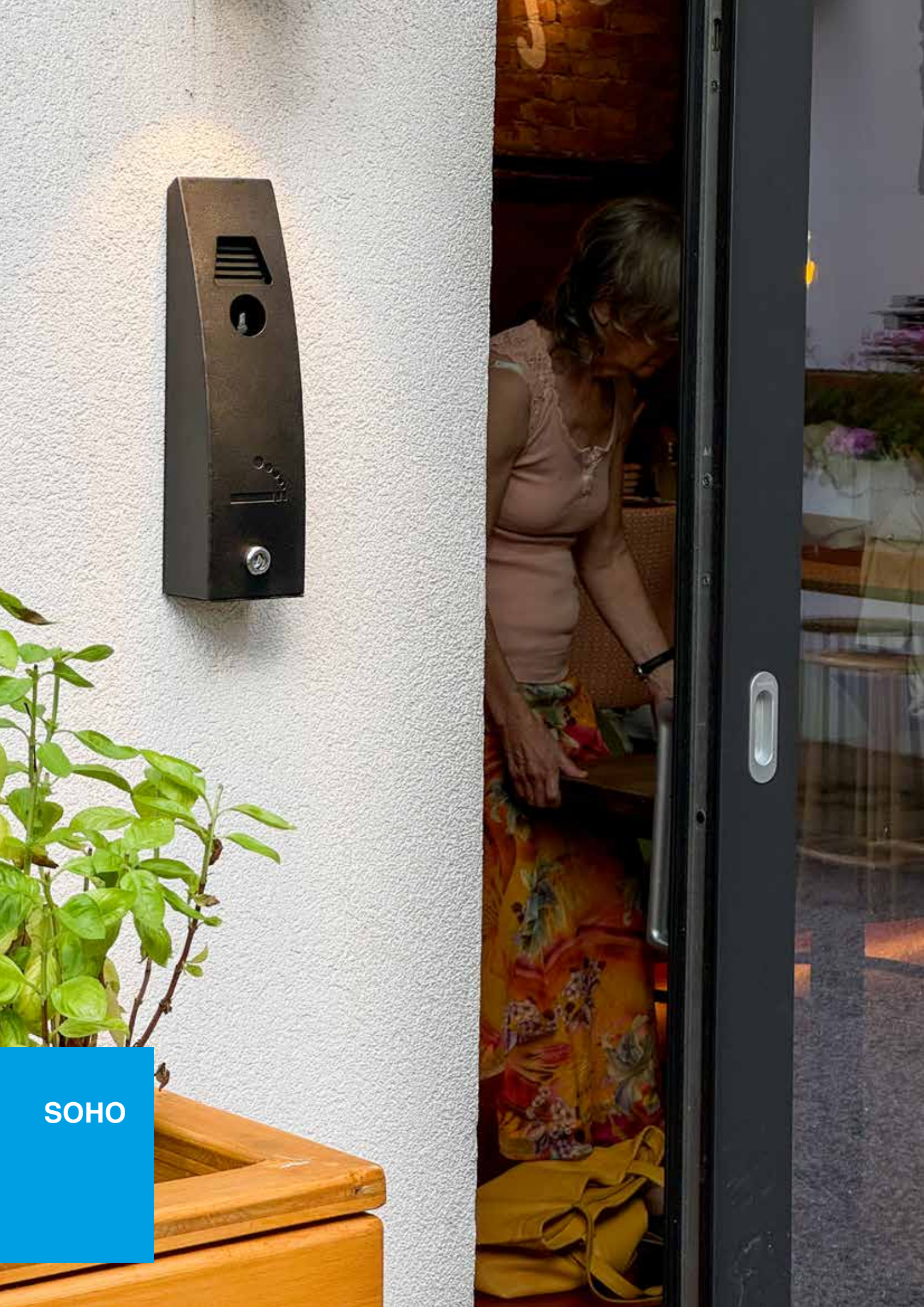

SOHO



## Soho

The SOHO model empties cigarette waste directly into an external bin, simplifying maintenance for outdoor settings. Made from galvanized steel with a powder coating or stainless steel, it offers a sleek look and durability.

- **Direct Emptying:** Transfers cigarette waste straight to an external bin, reducing handling time.
- **Durable Construction:** Crafted from galvanized steel with a powder coating or stainless steel for long-lasting use.
- **Safety:** minimizes fire hazards.
- **Cigarette-Specific Entry:** Designed to accept cigarettes only, preventing misuse as a general trash bin.
- **Versatile Installation:** Easily mountable on walls or poles to fit various outdoor environments.
- **Lockable:** Prevents unauthorized access and tampering.

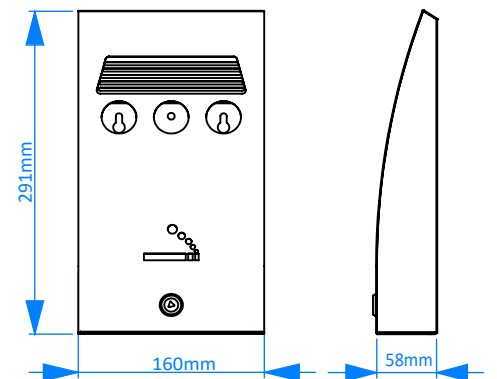
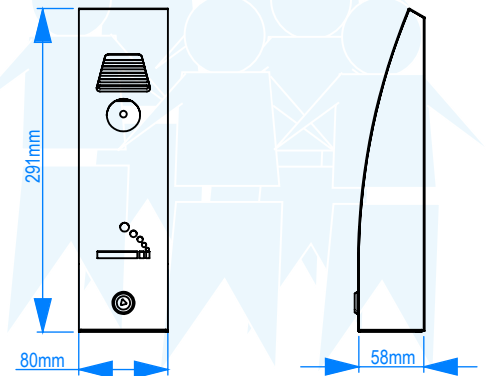

Item #	Item Description	Outer Box				
		PU	H (cm)	L (cm)	W (cm)	GW (kg)
03023	SOHO Mini, Black	10 in 1 Box	38	47	24	7.5
03024	SOHO Mini, Dark Gray	10 in 1 Box	38	47	24	7.5
03079	SOHO Mini, Inox Brushed	10 in 1 Box	38	47	24	7.5
03089	SOHO Midi, Black	4 in 1 Box	38	47	24	7.5
03090	SOHO Midi, Dark Gray	4 in 1 Box	38	47	24	7.5
03091	SOHO Midi, Inox Brushed	4 in 1 Box	38	47	24	7.5

# Modern Art Academy

## TUBE

Wall and Floor

Invitation Only.



## Tube

- For outdoor use: made of stainless steel or stainless steel with powder coating
- Easy maintenance: removable internal container.
- Reduced smoke and fire danger. Oxygen-suffocating-design
- Holes for cigarette waste are made to fit cigarettes only - preventing misuse as trash bin
- Wall, pole or floor mount
- Lockable

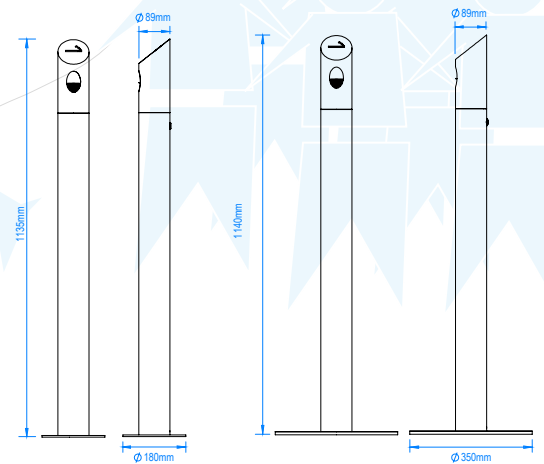
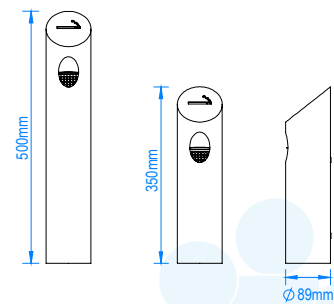

Item #	Item Description	PU	Outer Box			
			H (cm)	L (cm)	W (cm)	GW (kg)
00159	Tube Mini Black	4 in 1 Box	41	31	23	7
00183	Tube Mini Cig	4 in 1 Box	41	31	23	6.7
00453	Tube Mini Dark Gray	4 in 1 Box	41	31	23	7
01390	Tube Mini RAL 7043	4 in 1 Box	41	31	23	7
00161	Tube Mini Stainless	4 in 1 Box	41	31	23	6.7
01422	Tube Midi Black	4 in 1 Box	23	61	28	8.1
00451	Tube Midi Cig	4 in 1 Box	23	61	28	8.1
00450	Tube Midi dark Gray	4 in 1 Box	23	61	28	8.1
01391	Tube Midi RAL 7043	4 in 1 Box	23	61	28	8.1
00449	Tube Midi Stainless	4 in 1 Box	23	61	28	8.1
01092	Tube Maxi Fix Kit Dark Gray	4 in 1 Box	22	118	22	21
01093	Tube Maxi Fix Kit Stainless	4 in 1 Box	22	118	22	21
01091	Tube Maxi fs Kit (main body)	4 in 1 Box	22	118	22	18.4
	Tube Maxi fs base	2 in 1 Box	8	42	42	19.2
01090	Tube Maxi fsp Kit Dark Gray (main body)	4 in 1 Box	22	118	22	18.4
	Tube Maxi fsp base	2 in 1 Box	8	42	42	19.2

## Tower



- For outdoor use: made of stainless steel or Galvanized steel with powder coating. On all models the top is made of stainless steel.
- Reduces smoke emission and danger of fire: Internal container equipped with an oxygen-suffocating-cover. Combo Tower waste and cigarette liners completely separated.
- Easy maintenance: removable internal container. Stub out zone made of stainless steel is easy to wipe.
- Includes a liner for waste (Combo only) and a separate liner for cigarette waste.
- For mounting on solid ground with stainless steel anchors (included in the accessories).
- Holes for cigarette waste are made to fit cigars and cigarettes only - preventing misuse as trash bin
- The inclined top prevents waste from being placed on the bin and keeps it free of snow.
- Lockable

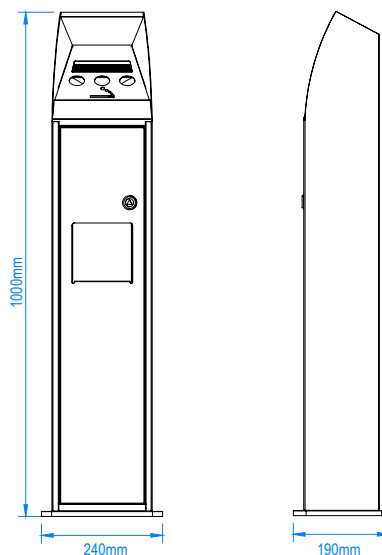

Item #	Item Description	PU	Outer Box			
			H (cm)	L (cm)	W (cm)	GW (kg)
00440	Combo Tower Black/Stainless	1 in 1 Box	103	26	20	13
02630	Combo Tower Dark Gray/Stainless	1 in 1 Box	103	26	20	13
00131	Combo Tower Stainless	1 in 1 Box	103	26	20	13
00441	Cig Tower Black/Stainless	1 in 1 Box	103	24	19	13.8
01483	Cig Tower Dark Gray/Stainless	1 in 1 Box	103	24	19	13.8
00442	Cig Tower Stainless	1 in 1 Box	103	24	19	13.8



## Tower Square



- For outdoor use: made of stainless steel or galvanized steel with powder coating. On all models the top is made of stainless steel.
- Reduces smoke emission and danger of fire: Internal container equipped with an oxygen-suffocating-cover
- Easy maintenance: removable internal container. Stainless steel top is easy to wipe
- For mounting on solid ground with stainless steel anchors (included in the accessories).
- Holes for cigarette waste are made to fit cigars and cigarettes only - preventing misuse as trash bin
- User friendly top, ideal for designated smoking areas.
- Lockable

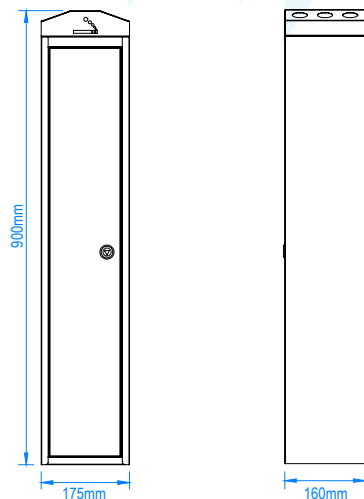
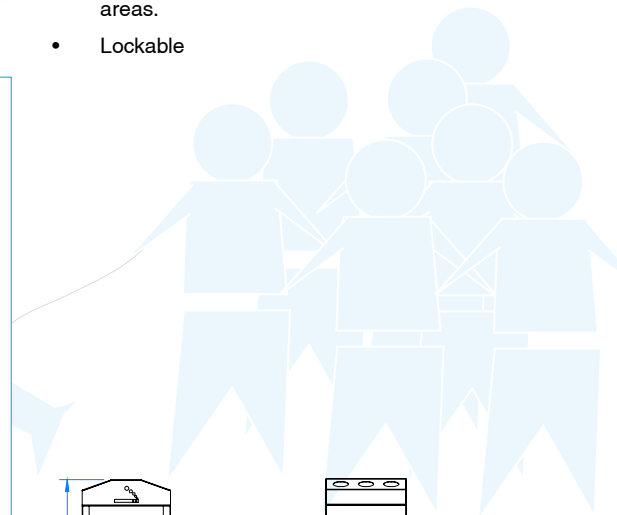

Item #	Item Description	PU	Outer Box			
			H (cm)	L (cm)	W (cm)	GW (kg)
01240	Tower Square Black	1 in 1 Box	90	17.5	16	10.4
01398	Tower Square dark Gray	1 in 1 Box	90	17.5	16	10.4
01299	Tower Square RAL 7043	1 in 1 Box	90	17.5	16	10.4
01239	Tower Square Stainless	1 in 1 Box	90	17.5	16	10.4

# Smoking Signs



## Smoking signs

- For outdoor use
- Robust: made of galvanized steel with powder coating.
- Print can be customized

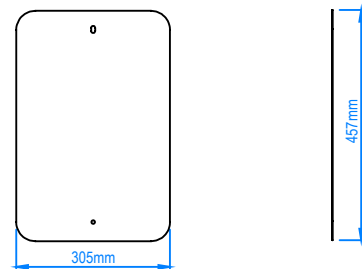
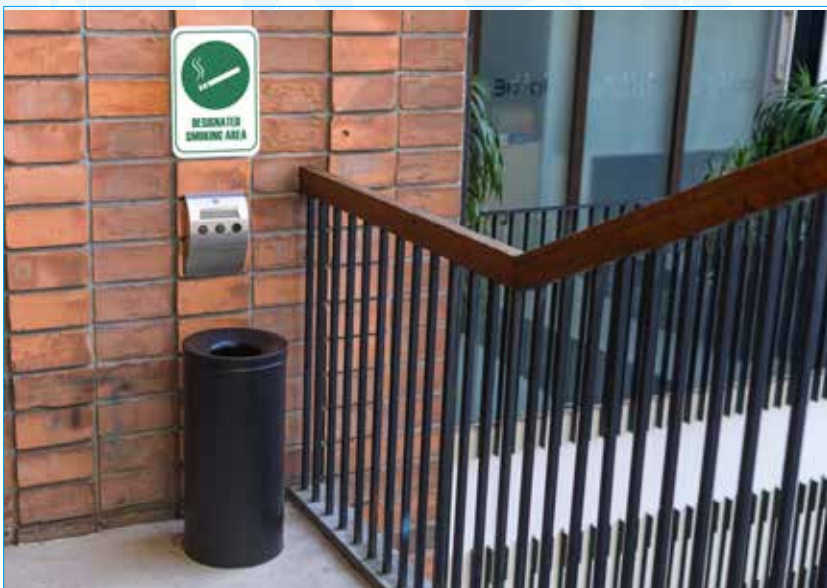

Item #	Item Description	PU	Outer Box			
			H (cm)	L (cm)	W (cm)	GW (kg)
02427	Designated Smoking Area Sign Maxi, GSPC Blue, DE	10 in 1 Box	50	33	18	13
02426	Designated Smoking Area Sign Maxi, GSPC Blue, EN	10 in 1 Box	50	33	18	13
02425	Designated Smoking Area Sign Maxi, GSPC Green, EN	10 in 1 Box	50	33	18	13
02429	No Smoking Sign Maxi, GSPC Red, DE	10 in 1 Box	50	33	18	13
02428	No Smoking Sign Maxi, GSPC Red, EN	10 in 1 Box	50	33	18	13

# Cigarette Receptacles Accessories

## Cigarette bin liners



00345 Cig Tower Liner

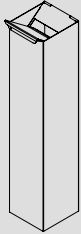

01263 Tower Square Liner



00477 Combo Tower Liner l



00476 Combo Tower Liner s

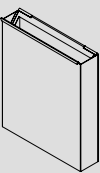

02638 Slim Line Maxi Liner

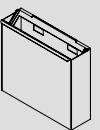

02639 Slim Line Midi Liner

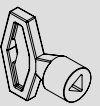

00472 Key, Triangle L



00144 Key, Triangle S



00038 Acryl Frame A4 AD Line & Karpas

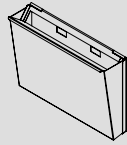

00480 Curved Maxi Liner

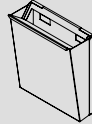

01306 Curved Midi Liner



01307 Curved Mini Liner



01310 Tube Maxi Liner

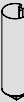

00473 Tube Midi Liner



00287 Tube Mini Liner

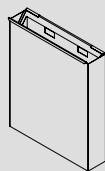

00478 AD Line Liner

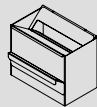

00471 Curved Classic Liner



00560 Lock, Triangle L, with 2 keys



00643 Lock, Triangle S, with 2 keys



00278 SS Cover for Acryl Frame A4 AD Line

## Locks and keys

## AD Line accessories



## CANINE

### Dog Waste Stations

Fepro pet waste stations help solve the problem of dog waste clean-up! Our commercial dog waste stations are the best choice for any community, urban area, or owner of public spaces! Made of commercial-grade and durable materials, our canine line provides headache-free operation for many years and is designed to fit most header pet waste bags.



## Canine Eco



- Holds 500 dog waste bags
- Strong and robust structure, ideal for public places.
- Lockable
- For outdoor use: Made of galvanized steel with powder coating
- For wall or pole mount
- Easy bag access
- Compatible with most header bags



Fire safety compliance according EN 13501-1 (DIN 4102-1)

Items 02420, 02414, 02412 and 00835  
Classification A2-s1,d0

Item 02734  
Classification A1

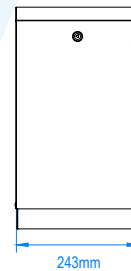
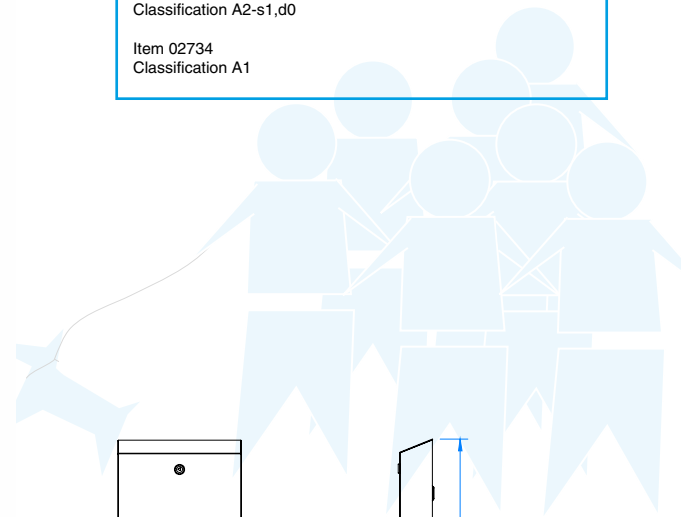

Item #	Item Description	PU	Outer Box				HS Code	Availability
			H(cm)	L(cm)	W(cm)	GW(kg)		
02420	Canine eco, Black	4 in 1 Box	50	34	28	11.5	7326909000	BTO
02414	Canine eco, Dark Gray	4 in 1 Box	50	34	28	11.5	7326909000	BTO
02412	Canine eco, Green	4 in 1 Box	50	34	28	11.5	7326909000	Stock
02734	Canine eco, Inox	4 in 1 Box	50	34	28	10	7326909000	Stock
00835	Canine eco, Silver	4 in 1 Box	50	34	28	11.5	7326909000	Stock



## Canine AD Line

- With advertising window in A4 size.
- Panel made of clear acrylic and backed by a steel panel.
- Images are easy to change, the acrylic window can be removed, opened and cleaned.
- Lockable restricting access to Advertising panel.
- For outdoor use: made of galvanized steel with powder coating
- For wall or pole mount

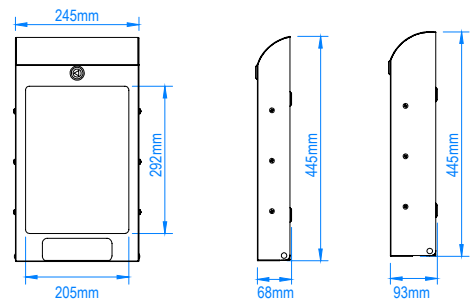

Item #	Item Description
02415	Canine AD Line XL, Black
02127	Canine AD Line XL, Dark Gray
02126	Canine AD Line XL, Green
02416	Canine AD Line, Black
01397	Canine AD Line, Dark Gray
00083	Canine AD Line, Green

PU	Outer Box			
	H (cm)	L (cm)	W (cm)	GW (kg)
4 in 1 Box	51	42	31	17.5
4 in 1 Box	51	42	31	17.5
4 in 1 Box	51	34	31	15.5
4 in 1 Box	51	34	31	15.5
4 in 1 Box	51	34	31	15.5



## Canine Classic

- Strong and Robust structure, ideal for public places.
- Lockable
- For outdoor use: Made of galvanized steel with powder coating
- For wall or pole mount

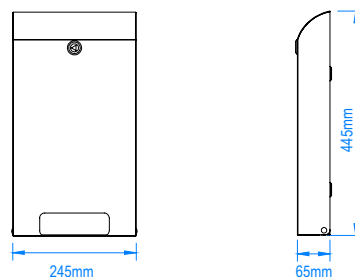

Item #	Item Description
02419	Canine Classic, Black
02413	Canine Classic, Dark Gray
00515	Canine Classic, Green
02411	Canine Classic, Silver

PU	Outer Box			
	H (cm)	L (cm)	W (cm)	GW (kg)
4 in 1 Box	50	34	28	13.5
4 in 1 Box	50	34	28	13.5
4 in 1 Box	50	34	28	13.5
4 in 1 Box	50	34	28	13.5

## Canine Signs



- For outdoor use
- Robust: made of galvanized steel with powder coating.
- Print can be customized

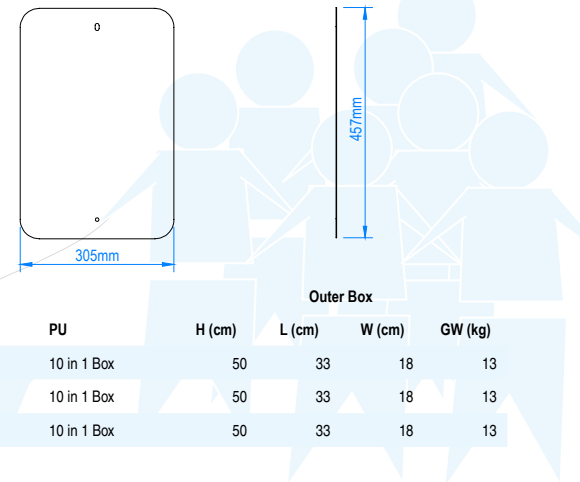

Item #	Item Description	PU	H (cm)	Outer Box			GW (kg)
				L (cm)	W (cm)		
02422	Canine Cleanup Sign Maxi, GSPC Green, DE	10 in 1 Box	50	33	18	13	
02421	Canine Cleanup Sign Maxi, GSPC Green, EN	10 in 1 Box	50	33	18	13	
02424	Canine Cleanup Sign Maxi, GSPC Green, no text	10 in 1 Box	50	33	18	13	



## Canine Bags

- HDPE Header Bags
- 100pcs/header
- Thick material for safe usage
- Dash Dot Dash holes for universal usage
- Fit on all our Canine Dispensers

Item #	Item Description	PU	H (cm)	Outer Box			GW (kg)
				L (cm)	W (cm)		
01187	Canine Bags 100 Header, Black, 14 mic, Klinsquare	50 in 1 Box	25	38	34	12	
00892	Canine Bags 100 Header, Black, 14 mic, Neutral	50 in 1 Box	25	38	34	12	

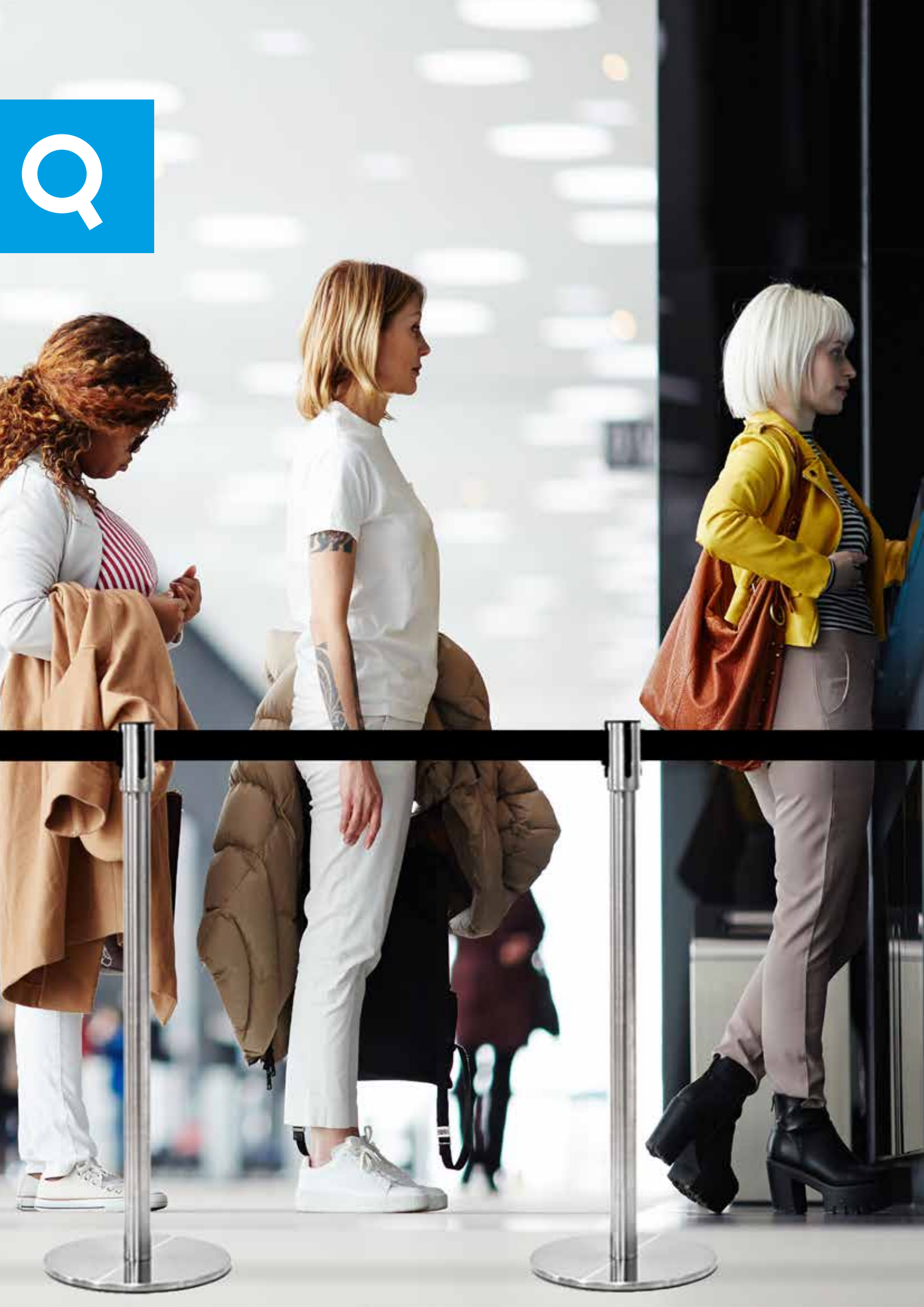



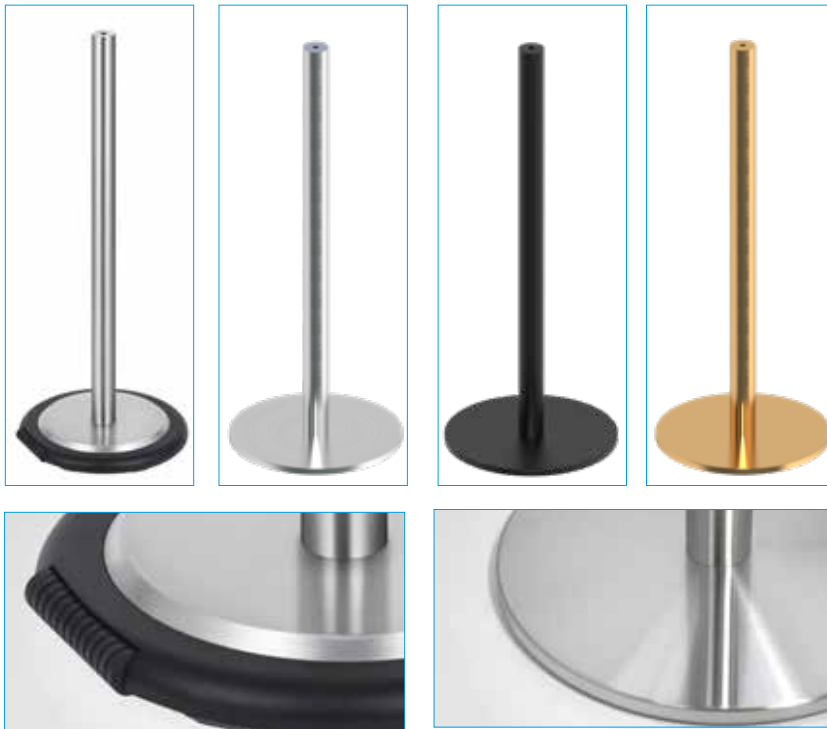

## Q EZI

- Modular: this modular system enables various combinations, reducing order losses due to missing inventory.
- Stable structure: with double lock system to avoid wobbling
- Flexible: many possible combinations for crowd control and/or signage
- Easy assembly

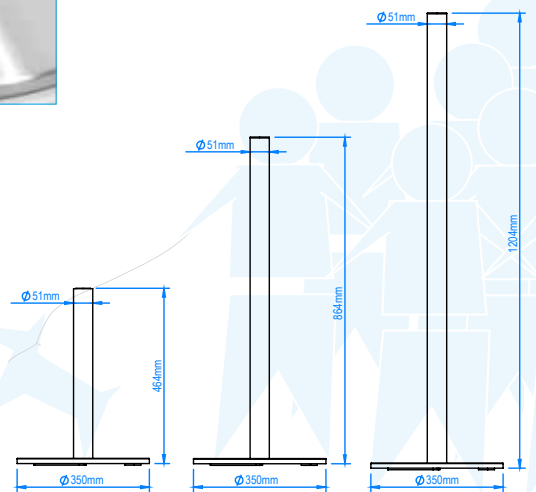
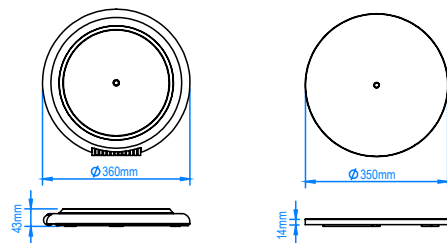

### Outer Box

Item #	Item Description	PU	H (cm)	L (cm)	W (cm)	GW (kg)
01333	Q EZI Pole 3.8 x 175 brushed	10 in 1 box	183	30	12	15.5
01332	Q EZI Pole 3.8 x 175 PC Black	10 in 1 box	183	30	12	15.5
02300	Q EZI Pole 3.8 x 55 brushed	10 in 1 Box	61	33	13	5
02301	Q EZI Pole 3.8 x 55 Gold	10 in 1 Box	61	33	13	5
02299	Q EZI Pole 3.8 x 55 PC Black	10 in 1 Box	61	33	13	5
01334	Q EZI Pole 3.8 x 96 brushed	10 in 1 Box	104	30	12	9.4
01359	Q EZI Pole 3.8 x 96 Gold	10 in 1 Box	104	30	12	9.4
01335	Q EZI Pole 3.8 x 96 PC Black	10 in 1 Box	104	30	12	9.4
02399	Q EZI Pole 5.1 x 119 brushed	10 in 1 Box	127	36	15	15.4
02400	Q EZI Pole 5.1 x 119 PC Black	10 in 1 Box	127	36	15	15.4
01336	Q EZI Pole 5.1 x 45 brushed	10 in 1 Box	52	36	15	5.8
01360	Q EZI Pole 5.1 x 45 Gold	10 in 1 Box	52	36	15	5.8
01358	Q EZI Pole 5.1 x 45 PC Black	10 in 1 Box	52	36	15	5.8
01337	Q EZI Pole 5.1 x 85 brushed	10 in 1 Box	92	36	15	11
01338	Q EZI Pole 5.1 x 85 Gold	10 in 1 Box	92	36	15	11
01339	Q EZI Pole 5.1 x 85 PC Black	10 in 1 Box	92	36	15	11
01330	Q EZI base 35 Black	2 in 1 Box	8	42	42	19.5
01329	Q EZI base 35 Gold	2 in 1 Box	8	42	42	19.5
01331	Q EZI base 35 Stainless	2 in 1 Box	8	42	42	19.5
01372	Q EZI base ergo	2 in 1 Box	18	36	36	16

## 4way Retractable Barrier

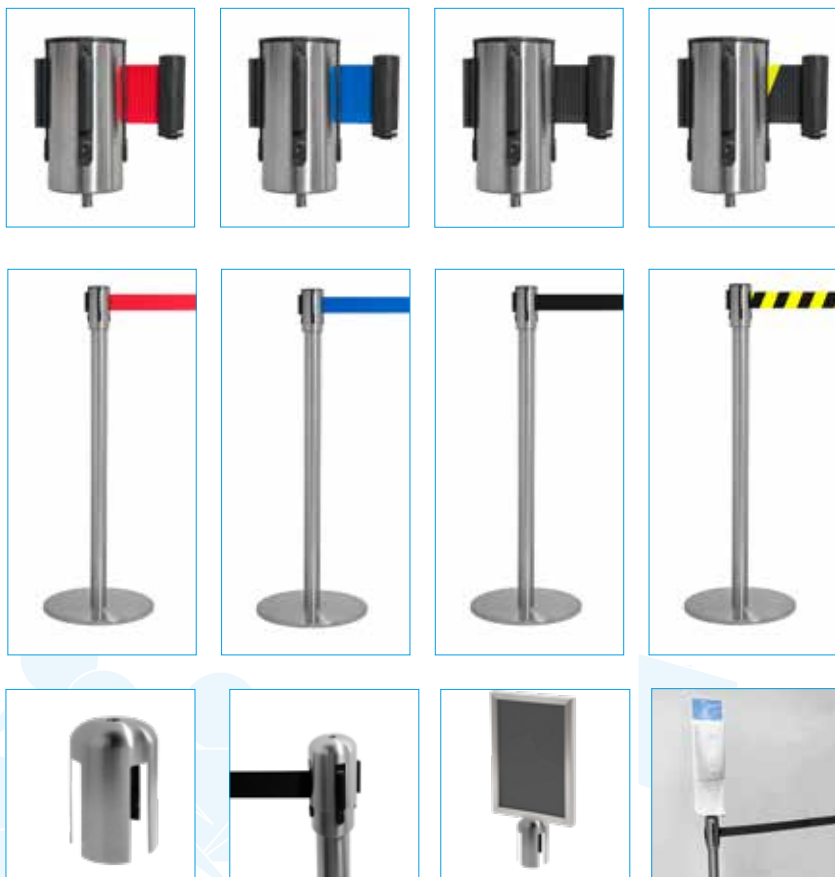

- 4 way retractable cassettes fitting our Q EZI
- 2m or 3m long belt
- End piece lockable
- Red, blue, black and black /yellow
- Other colors and print available upon request
- Ext adapter enables various extension including signage, dispensers for bags or gloves

Item #	Item Description	PU	H (cm)	Outer Box			GW (kg)
				L (cm)	W (cm)		
00884	Q Cassette Adapter ext, Black	50 in 1 Box	26	46	42	11.5	
00411	Q Cassette Adapter ext, brushed	50 in 1 Box	26	46	42	11.5	
01373	Q Cassette Adapter ext, Gold	50 in 1 Box	26	46	42	11.5	
01180	Q Cassette Black, Belt Black, 2m, for wall	50 in 1 Box	28	62	41	23	
01365	Q Cassette Black, Belt Black, 3m, for wall	50 in 1 Box	28	62	41	26	
00591	Q Cassette brushed, Belt Black, 2m, for wall	50 in 1 Box	28	62	41	23	
01366	Q Cassette brushed, Belt Black, 3m, for wall	50 in 1 Box	28	62	41	26	
00761	Q Cassette brushed, Belt Black/Yellow, 2m, for wall	50 in 1 Box	28	62	41	23	
01367	Q Cassette brushed, Belt Black/Yellow, 3m, for wall	50 in 1 Box	35	62	28	26	
00594	Q Cassette brushed, Belt Blue, 2m, for wall	50 in 1 Box	28	62	41	23	
01368	Q Cassette brushed, Belt Blue, 3m, for wall	50 in 1 Box	28	62	41	26	
00593	Q Cassette brushed, Belt Red, 2m, for wall	50 in 1 Box	28	62	41	23	
01369	Q Cassette brushed, Belt Red, 3m, for wall	50 in 1 Box	28	62	41	26	
00905	Q Cassette Black, Belt Black, 2m	50 in 1 Box	35	45	41	23	
01361	Q Cassette Black, Belt Black, 3m	50 in 1 Box	35	45	41	26	
01223	Q Cassette Black, Belt Red, 2m	50 in 1 Box	35	45	41	23	
01363	Q Cassette Black, Belt Red, 3m	50 in 1 Box	35	45	41	26	
00419	Q Cassette brushed, Belt Black, 2m	50 in 1 Box	35	45	41	23	
01302	Q Cassette brushed, Belt Black, 3m	50 in 1 Box	35	45	41	26	
00760	Q Cassette brushed, Belt Black/Yellow, 2m	50 in 1 Box	35	45	41	23	
01035	Q Cassette brushed, Belt Black/Yellow, 3m	50 in 1 Box	35	45	41	26	
00418	Q Cassette brushed, Belt Blue, 2m	50 in 1 Box	35	45	41	23	
01362	Q Cassette brushed, Belt Blue, 3m	50 in 1 Box	35	45	41	26	
00417	Q Cassette brushed, Belt Red, 2m	50 in 1 Box	35	45	41	23	
01303	Q Cassette brushed, Belt Red, 3m	50 in 1 Box	35	45	41	26	
01106	Q Cassette Gold, Belt Red, 2m	50 in 1 box	35	45	41	19	
01364	Q Cassette Gold, Belt Red, 3m	50 in 1 Box	35	45	41	26	



## Rope Barrier

- Cordfix for Q EZI Pole
- Available in Brushed Stainless, Gold and Black
- Cordfix sign enables Attachment of Q Clip or Q frames
- 1.5m Ropes available in various colors with chromed or gold hook)

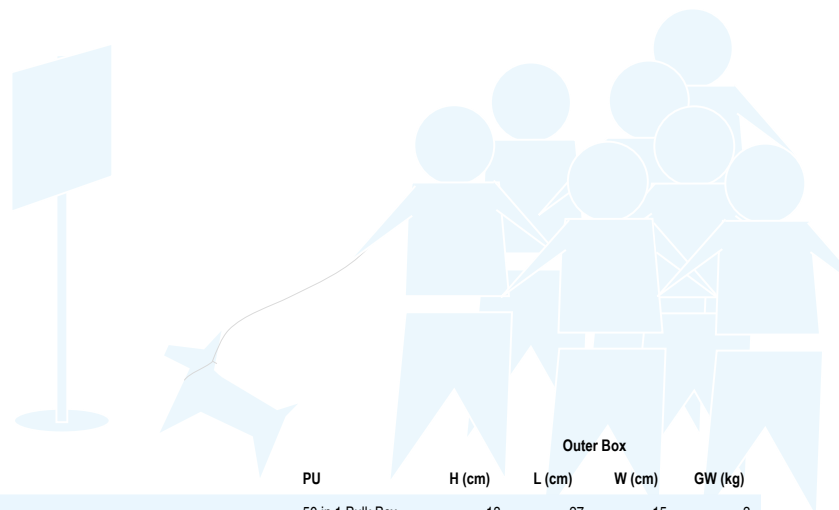
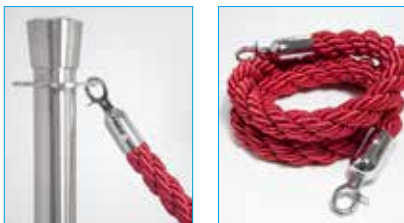

Item #	Item Description	PU	Outer Box			GW (kg)
			H (cm)	L (cm)	W (cm)	
02506	Q Cord Hook, 28, Chrome	50 in 1 Bulk Box	18	27	15	3
02505	Q Cord Hook, 28, Gold	50 in 1 Bulk Box	18	27	15	3
01169	Q Cordfix for wall Black	50 in 1 Bulk Box	4	31.5	31.5	8
00592	Q Cordfix for wall Chrome	50 in 1 Bulk Box	4	31.5	31.5	8
01168	Q Cordfix for wall Gold	50 in 1 Bulk Box	4	31.5	31.5	8
00754	Q Cordfix sign brushed	50 in 1 Box	29	63	47	17
01275	Q Cordfix sign Gold	50 in 1 Box	29	63	47	17
00883	Q Cordfix sign PC Black	50 in 1 Box	29	63	47	17
00420	Q Cordfix brushed	50 in 1 Box	29	63	47	17
01107	Q Cordfix Gold	50 in 1 Box	29	63	47	17
00882	Q Cordfix PC Black	50 in 1 Box	29	63	47	17
01349	Q Cord twist Black, Black fix, 28	20 in 1 Bulk Box	35	69	45	15
00679	Q Cord twist Black, Chrome fix 28	20 in 1 Bulk Box	35	69	45	15
01109	Q Cord twist Black, Gold fix, 28	20 in 1 Bulk Box	35	69	45	15
00745	Q Cord twist Blue, Chrome fix 28	20 in 1 Bulk Box	35	69	45	15
00746	Q Cord twist Champagne, Chrome fix 28	20 in 1 Bulk Box	35	69	45	15
02375	Q Cord twist Champagne, Gold fix 28	20 in 1 Bulk Box	35	69	45	15
01108	Q Cord twist Gold, Gold fix, 28	20 in 1 Bulk Box	35	69	45	15
00914	Q Cord twist Pink, Chrome fix 28	20 in 1 Bulk Box	35	69	45	15
00421	Q Cord twist Red, Chrome fix 28	20 in 1 Bulk Box	35	69	45	15
01110	Q Cord twist Red, Gold fix, 28	20 in 1 Bulk Box	35	69	45	15
01457	Q Cord twist Silver, Chrome fix 28	20 in 1 Bulk Box	35	69	45	15
00747	Q Cord twist White, Chrome fix 28	20 in 1 Bulk Box	35	69	45	15



## Q dispenser holder, Acri

- For Q EZI stand (requires 0° Adapter)
- Compatible with Q EZI Crowd Control
- Made of top quality 8mm Acrylic
- Fits all dispensers with center mounting hole

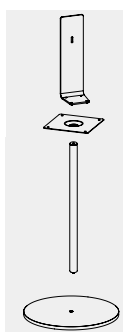
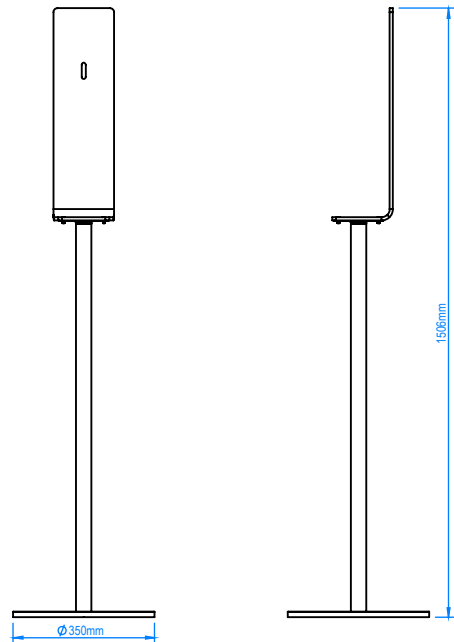
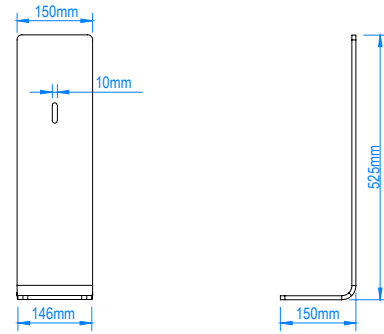

Item #	Item Description	PU	H (cm)	Outer Box			GW (kg)
				L (cm)	W (cm)		
02657	Q dispenser holder, Acri, Black	20 in 1 Bulk Box	44	78.5	47	21.2	
02646	Q dispenser holder, Acri, White	20 in 1 Bulk Box	44	78.5	47	21.2	
00414	Q Adapter 0°, brushed	50 in 1 Box	29.5	42	28.5	12.5	
01337	Q EZI Pole 5.1 x 85 brushed	10 in 1 Box	92	36	15	11	
01339	Q EZI Pole 5.1 x 85 PC Black	10 in 1 Box	92	36	15	11	
01334	Q EZI Pole 3.8 x 96 brushed	10 in 1 Box	104	30	12	9.4	
01335	Q EZI Pole 3.8 x 96 PC Black	10 in 1 Box	104	30	12	9.4	
01330	Q EZI base 35 Black	2 in 1 Box	8	42	42	19.5	
01331	Q EZI base 35 Stainless	2 in 1 Box	8	42	42	19.5	



## Q EZI Umbrella Bag and Glove Dispenser

- Q EZI stand with hooks for A5L or A4 signs
- Hooks hold umbrella bags or gloves
- Stable structure with double lock system to avoid wobbling



### Outer Box

Item #	Item Description	PU	H (cm)	L (cm)	W (cm)	GW (kg)
00907	Uni Clip Sign A4	30 in 1 Bulk Box	34	34	24	15
00906	Uni Clip Sign A5L	50 in 1 Bulk Box	19	55	25	11
02386	Q Clip Bag & Glove Dispenser Black	20 in 1 Box	49	37	27	8.5
02654	Q Clip Bag & Glove Dispenser Stainless	20 in 1 Box	49	37	27	8.5
01335	Q EZI Pole 3.8 x 96 PC Black	10 in 1 Box	10	104	30	9.4
01339	Q EZI Pole 5.1 x 85 PC Black	10 in 1 Box	10	92	36	11
01330	Q EZI base 35 Black	2 in 1 Box	2	8	42	42

Item #	Item Description	PU	H (cm)	L (cm)	W (cm)	GW (kg)
02409	Gloves, 100 Header, White, Neutral	100 in 1 Bulk Box	28	38	30	11.5
02407	Umbrella Bags Maxi, 100 Header, White, Neutral	20 in 1 Bulk Box	20	35	16	4.5
02408	Umbrella Bags Midi, 100 Header, White, Neutral	20 in 1 Bulk Box	12	35	16	2

## Post

- Posts for outdoor use
- Made of high-grade stainless steel or galvanized steel with powder coating.
- For fixing on hard surfaces with anchors, buried in concrete cast or on soft soil (requires Anchor)
- 3 sizes for various combinations of signs, waste and cigarette receptacles or dispensers for dog bags or gloves.
- All items can be attached at any height using our Post Fix Kit

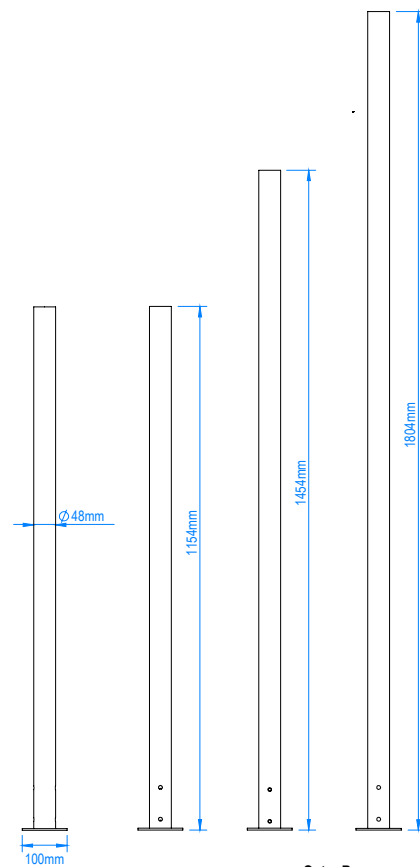

Item #	Item Description	Outer Box				
		PU	H (cm)	L (cm)	W (cm)	GW (kg)
01160	Post Anchor 10 GS	9 in 1 Box	55	35	35	14
01304	Post Fix Kit b2b, 32 - 67mm	50 in 1 Box	18	38	25	4.5
01161	Post Fix Kit, 32 - 67mm	50 in 1 Box	18	38	25	4.5
01162	POST Kit MAXI dark Gray	1 in 1 Box	12	183	12	4.5
01435	POST Kit MAXI RAL 6005	1 in 1 Box	12	183	12	4.5
01429	POST Kit MAXI RAL 7043	1 in 1 Box	12	183	12	4.5
01167	POST Kit MAXI SS	1 in 1 Box	12	183	12	4.5
01163	POST Kit MIDI dark Gray	1 in 1 Box	12	148	12	3.5
01463	POST Kit MIDI RAL 6005	1 in 1 Box	12	148	12	3.5
01430	POST Kit MIDI RAL 7043	1 in 1 Box	12	148	12	3.5
01166	POST Kit MIDI SS	1 in 1 Box	12	148	12	3.5
01164	POST Kit MINI dark Gray	1 in 1 Box	12	118	12	2.5
01464	POST Kit MINI RAL 6005	1 in 1 Box	12	118	12	2.5
01431	POST Kit MINI RAL 7043	1 in 1 Box	12	118	12	2.5
01165	POST Kit MINI SS	1 in 1 Box	12	118	12	2.5



## GAS Glove

- Robust structure for use indoor or outdoor
- Made of galvanized steel with powder coating
- Easy to refill
- Pole or wall mount

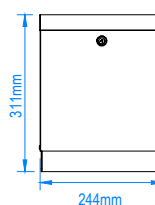

Item #	Item Description	PU	Outer Box			GW (kg)
			H (cm)	L (cm)	W (cm)	
02397	GAS Glove Dispenser, Black	4 in 1 Box	36	34	27	8.4
02396	GAS Glove Dispenser, Silver	4 in 1 Box	36	34	27	8.4
02409	Gloves, 100 Header, White, Neutral	100 in 1 Bulk Box	28	38	30	11.5



## Cyli Hygiene Wipe Station

- Wipe dispenser and receptacle
- Made of stainless steel
- Including a food-safe bucket that seals and keeps the wipes wet.
- used wipes can be disposed in the galvanized liner below

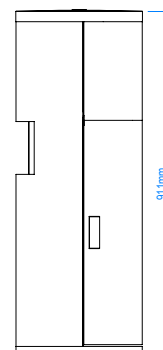
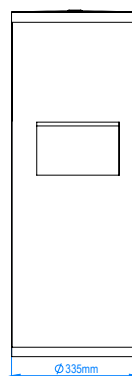

Item #	Item Description	PU	Outer Box			GW (kg)
			H (cm)	L (cm)	W (cm)	
02401	Cyli Hygiene Wipe Station	1 in 1 Box	95	38.5	38.5	13.1
02402	Cyli Hygiene Wipe Station, Body only	1 in 1 Box	95	38.5	38.5	13.1
00851	Bucket for Cyli Wipe Dispenser, white	52 in 1 Bulk Box	32	48	45	10

# Creating Solutions That Work

Product design and development	<ul style="list-style-type: none"><li>• CAD drawings and 3D modeling</li><li>• Initial samples / prototypes</li></ul>
Manufacturing	<p>We manufacture products made of:</p> <ul style="list-style-type: none"><li>• Stainless steel and galvanized steel sheets</li><li>• Aluminum profiles</li><li>• Acrylic / plastic sheets</li></ul>
Customization	<ul style="list-style-type: none"><li>• Branding</li><li>• Surface treatment</li><li>• Packaging</li></ul>
Quality certification	<p>We regularly have our products tested at accredited labs such as Intertek and SGS.</p>
Logistics	<p>We work with the world's leading logistics companies to ensure swift delivery to your warehouse. We will also be happy to cooperate with your appointed forwarder.</p>

We strive to make working with FEPRO as easy as possible. Contact us to learn more about us and how you can benefit from our professional services and manufacturing capability.

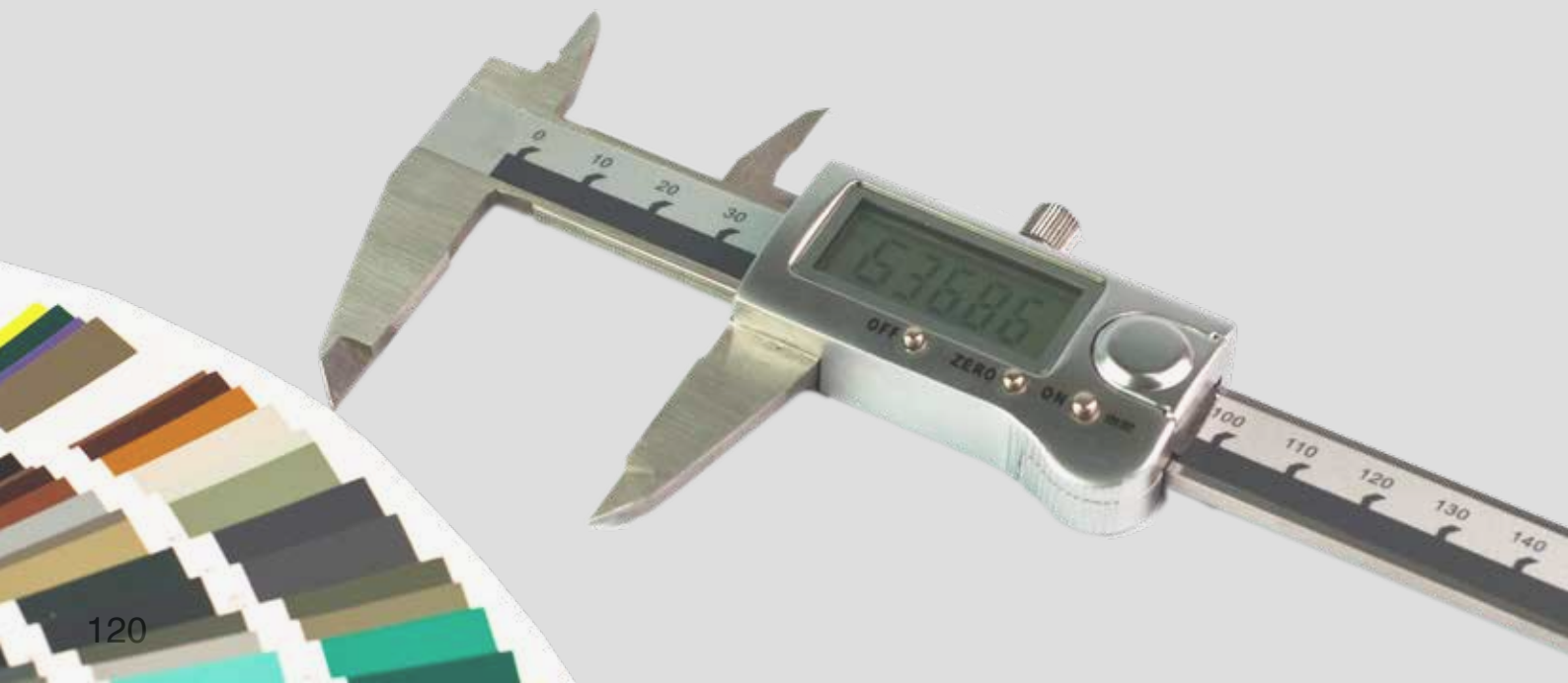



# ISO / DIN paper sizes in millimeters and in inches

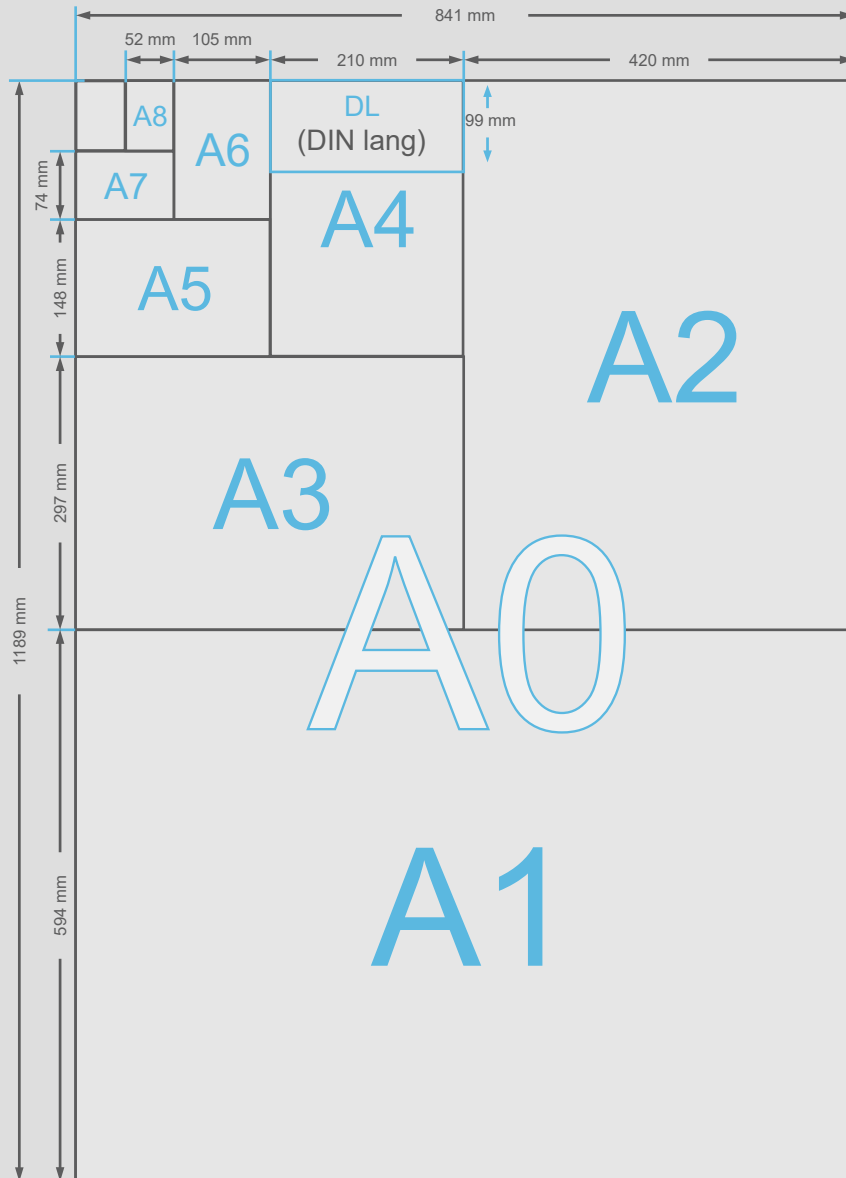

size	A Series Formats		B Series Formats		C Series Formats	
	in mm	in inches	in mm	in inches	in mm	in inches
0	841 × 1189	33.1 × 46.8	1000 × 1414	39.4 × 55.7	917 × 1297	36.1 × 51.1
1	594 × 841	23.4 × 33.1	707 × 1000	27.8 × 39.4	648 × 917	25.5 × 36.1
2	420 × 594	16.5 × 23.4	500 × 707	19.7 × 27.8	458 × 648	18.0 × 25.5
3	297 × 420	11.7 × 16.5	353 × 500	13.9 × 19.7	324 × 458	12.8 × 18.0
4	210 × 297	8.3 × 11.7	250 × 353	9.8 × 13.9	229 × 324	9.0 × 12.8
5	148 × 210	5.8 × 8.3	176 × 250	6.9 × 9.8	162 × 229	6.4 × 9.0
6	105 × 148	4.1 × 5.8	125 × 176	4.9 × 6.9	114 × 162	4.5 × 6.4
7	74 × 105	2.9 × 4.1	88 × 125	3.5 × 4.9	81 × 114	3.2 × 4.5
8	52 × 74	2.0 × 2.9	62 × 88	2.4 × 3.5	57 × 81	2.2 × 3.2
9	37 × 52	1.5 × 2.0	44 × 62	1.7 × 2.4	40 × 57	1.6 × 2.2
10	26 × 37	1.0 × 1.5	31 × 44	1.2 × 1.7	28 × 40	1.1 × 1.6



All images and texts © FEPRO Solutions Ltd. All rights reserved.  
All information is subject to change without prior notice

[www.feoproducts.com](http://www.feoproducts.com) | [sales@feoproducts.com](mailto:sales@feoproducts.com)

